

# INSTALLATION MANUAL

Connection Server

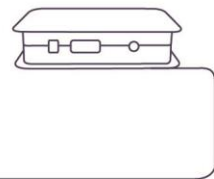

1.	Preface .....	3
2.	Launching the connection server .....	4
•	Bookmark Server .....	6
•	Bookmark Configuration .....	7
•	Bookmark System .....	10
•	Bookmark Media .....	12
•	Spotify .....	13
•	Bookmark HA-BUS .....	14
•	Bookmark RF Configuration .....	16
•	Bookmark Logging .....	16
•	Bookmark Zones .....	17
•	EventScript .....	18
•	Bookmark A/C .....	24
•	Bookmark ESS .....	29
•	Bookmark Rooms .....	32
•	Bookmark Cameras .....	34
•	Bookmark Miele .....	35
•	Bookmark Intercoms .....	36
•	Bookmark Energy .....	38
•	Bookmark Weather .....	44
•	Bookmark Aseko .....	46
•	Bookmark Manual .....	47
•	Bookmark Default settings .....	47
•	Bookmark Audit .....	47
•	Bookmark Logout .....	47
3.	Connection Server update server .....	48
4.	Appendix .....	50

## 1. Preface

Connection Server - It serves as a connection between iNELS BUS system units and other devices because it allows communication between devices with different protocols. All devices can be then controlled through just one application. Besides the normal control of electronic installations, you can also control e.g. air condition, home appliances.

The connection server uses a small but powerful computer, Raspberry PI B+, 3 with really low power consumption and the Linux operating system.

In comparison with iMM Server, multimedia is not implemented here.

### Protocols

RPC	communication with application smartphones and tablets
Elkonet	communication with central unit iNELS BUS
Miele	communication with home appliances Miele
Camcontrol	communication with IP cams
Artea	communication with the Artea air handling unit
Coolmaster	communication with gateway for air conditioning
Airpohoda	communication with the Airpohoda air handling
eLAN-RF	communication with wireless components of iNELS RF Control

### Notes

- ⇒ Commands are given in purple (e.g.: `sudo reboot`)
- ! Warnings are given in red (e.g.: **Connection server it allows you to set up only one door intercom.**)
- 📌 Tips and tricks are given in green (e.g.: **In the list of devices, we can add and remove devices manually**)

### Important application configuration commands in Linux (insert into terminal)

<code>ifconfig</code>	- finding IP address of station/server, similar to ipconfig in Windows
<code>mount</code>	- command for connection of certain device (CDROM, network drive, flash disk, etc.)
<code>umount</code>	- command for disconnection of certain device
<code>man</code>	- command man displays help e.g. man mount
<code>sudo shutdown -h now</code>	- command shut down device Connection server from terminal
<code>sudo poweroff</code>	- command shut down device Connection server from terminal
<code>sudo reboot</code>	- command reboot device Connection server from terminal

## 2. Launching the connection server

- a) Once you unpack the Connection server, let the device stabilize at room temperature.
- b) Insert the micro SD card with the operating system into the slot. In newer CS revisions, the SD card is already inserted.
- c) Connect the cabling (do not connect the supply yet):
- Display HDMI device
  - LAN cable for Ethernet port
  - Keyboard to USB port

For proper functionality we recommend connecting Connection Server to UPS (Uninterruptible Power Supply).

- d) After connecting power supply (adapter with micro USB connector) the Connection Server will start automatically.
- e) When starting the system you can watch the opening of individual services on the screen.

- f) When services start up is completed, only one line, requiring the login name will appear on the screen

```
Login:      imm
Password:   imm123
```

! No characters are display when writing a password in terminal

- g) To find the IP address after signup use the command ifconfig or extract it from the previous statement.

- h) Further settings are performed via the IMM Control Centre web interface. A display device or keyboard need not be connected for the remaining time. Power supply, micro SD card with system and application and connection to network LAN is sufficient to run Connection Server.

! Never insert or remove the micro SD card for running the Server Connection

### List of usable ports:

Port	Protocol	Description
8080	TCP	Connection Server - access to web-interface
8081	TCP	Connection Server - access to update server web-interface
9000	TCP	Connection Server - access to web-interface of LMS Audio zone and Audio player GUI
9001	TCP	Connection Server - access to daemon supervisor web-interface overview (daemon maintenace and logging)
8090	TCP	iMM Client - access to web-interface client part
61695	TCP	LARA - access to web-interface / remote control for third-party devices and applications
62000	TCP	LARA - access to port related to DLNA server. It is based on UPnP to stream audio content.
80	TCP	eLANRS485-232 - access to web-interface
8000	TCP	iHC applications - access to encrypted communication between applications and Connection Server / IMM server
9999	UDP	iHC applications - access to communication between applications and central unit CU3
61682	UDP	iHC applications - access to communication between applications and central unit CU2
9999	UDP	iHC applications - access to communication between applications and RFPM-2M
80	TCP	eLAN RF - access to web-interface
8001	TCP	iHC applications - access to unencrypted communication between applications and Connection Server / IMM server

More detailed description of the port use:

[https://en.wikipedia.org/wiki/List\\_of\\_TCP\\_and\\_UDP\\_port\\_numbers](https://en.wikipedia.org/wiki/List_of_TCP_and_UDP_port_numbers)

## Configuration in IMM Control Center - Connection Server

iMM Control Center (hereinafter "iMM CC") is a web interface for adjusting the Connection Server.

iMM CC will run when you enter the address <http://IPADRESA:8080> into your web browser and login using the access data.

Login data is by default the following settings: "admin", password "imm123"

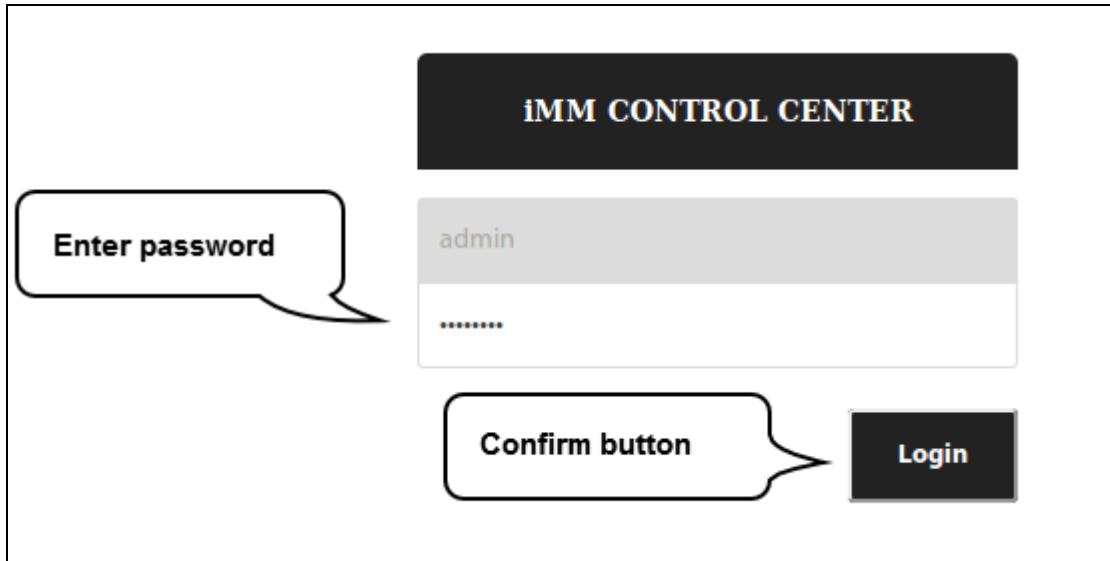

If iMM CC does not run, connect to the server using the SSH protocol with the IP address of the Connection Server and enter it into the terminal

⇒ Command: `sudo /etc/init.d/imm-web admin restart`.

### SSH authorization

Login: imm  
Password: imm123

! You can change the Default password, in the terminal: `passwd imm`

i PuTTY is freeware that you can use to connect via SSH to the iMM CC web interface in Windows or Linux.

i Website will be automatic logout after 15 minutes of inactivity.

- **Bookmark Server**

In bookmark Server you can control the services, which are necessary for communication with a third party. With the software diagnostic is possible to check each service status (button „Status“), to stop running (button „Stop“), or vice versa to start running (button „Start“).

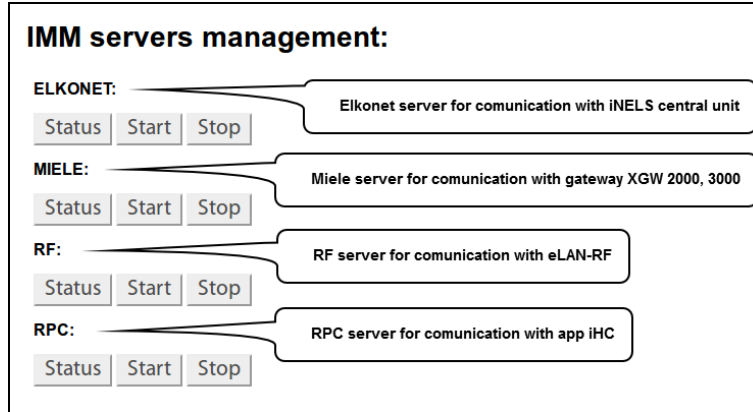

 You can control all the virtual servers via Supervisor service link <http://IPADRESA:9001>

Function Display log:

To display the logs of the main server protocols, click on the individual names to display their listings in the next tab of the browser..

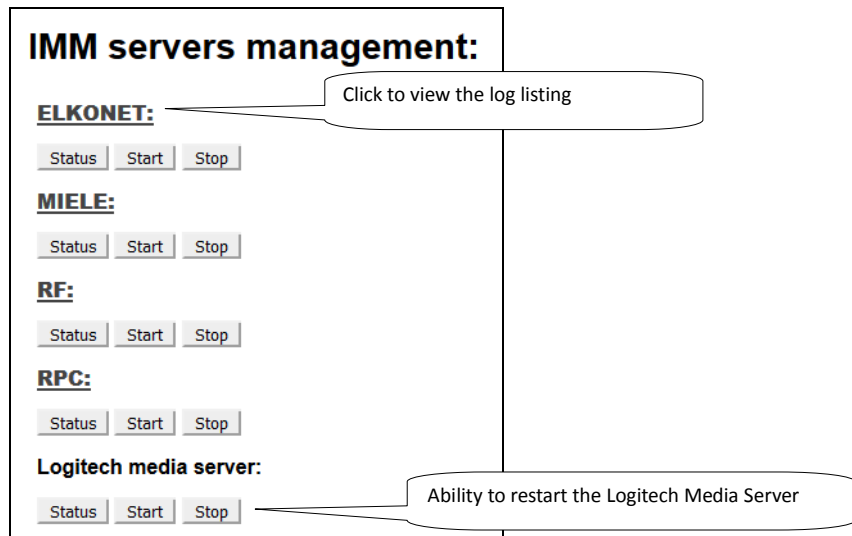

- **Bookmark Configuration**

The configuration tab is used to setup the primary Connection Server and is necessary for proper function..  
Machine ID and Licence key are pre-set in factory default.

**a) Settings**

**IP address input formats:**

If the central unit is on a different computer network behind a router (NAT) and is not available directly, it can be connected to it over a selected open port on the router, which is connected to the communications port CU (CU2 port 61682, CU3 port 9999).

Version CU	Format	Example:
CU2	[IPADDRESS]:[COMUNICATION_PORT]	10.5.15.12:8454
CU3	[IPADDRESS]:[HTTP_PORT]:[COMUNICATION_PORT]	10.5.15.12:8080:4562

**Communication port** - Elkonet for iMM server, Connection server, App iHC (CU2 port 61682, CU3 port 9999).

**HTTP port** - is the web server on CU3 where the created export.imm file is usually stored in the location  
http://IPADRESA/immfiles/export.imm (port 80)

**ASCII port** - port for communication with CU3 with a three-way third-party protocol (Telnet), which must first be set in IDM (optional), is set, the port for ASCII communication is 1111.

**Password** - password to access the central controller of the program is set in the IDM (optional)

Example setup menu settings:

The screenshot shows the 'Settings' and 'Export iNELS3' sections of the iNELS interface. Callouts provide the following information:

- Settings:**
  - IP of iNELS CU:** 10.10.5.186 (Callout: Enter the IP address of the central unit)
  - Password:** ..... (Callout: Enter the specified password for IDM)
  - ASCII port (optional):** (Callout: Enter the communication port for ASCII)
  - IP of iMM Server:** 127.0.0.1 (Callout: Enter the IP address of the Connection Server)
  - Device Name:** Conn-Server
  - Machine ID:** 2b6c8c846b528b1ed9ef1268d84723ef (Callout: Key ID)
  - Licence key:** 81594496cd2b8bf7 (Callout: Licence Key)
  - Buttons: update, Check iNELS3 CU
- Export iNELS3:**
  - Buttons: Load export CU3 iNELS3, Delete export
  - Dropdown: iS3
  - Buttons: Load iNELS3 export, Delete iNELS3 export
  - Text: iNELS3 current export header
  - Text: Export header: VERSION\_01-03-03\_CREATE\_2019-09-09-13-14-42\_IDM3\_03-03-34\_ID\_98BB61B2EF1B5F49B6F63D350E5D9AAE\_NAME\_IMM-kufr-20180110
- Export iNELS2:**
  - Buttons: Upload iNELS2 export, Delete iNELS2 export
  - Text: Upload: Vybrat soubor, Soubor nevybrán

Clicking on button Check iNELS3 CU will show central unit state including password authentication state.

The screenshot shows a web interface for checking the iNELS3 CU state. The top section, titled "CU STATE", has a light green background and contains the following text: "CU address: 10.10.3.34:9999", "CU connection: CONNECTED", "CU state: CU is RUNNING (0x20)", "Protocol version: 00.02.00", "User password enabled: True", and "Login state: OK". Callout boxes point to "CU IP address" (10.10.3.34:9999), "CU current state" (CU is RUNNING (0x20)), and "CU password verification enabled" (User password enabled: True). Below this is a "Settings" section with input fields for: "IP of iNELS CU:" (10.10.3.34), "Password:" (masked with dots), "ASCII port (optional):", "IP of IMM Server:" (192.168.88.55), "Machine ID:" (1224b1e5dc751f937263b45541a12439), and "Licence key:" (612bdf592b1e0d69). At the bottom are "update" and "Check iNELS3 CU" buttons. On the left, callouts point to "CU connection state" (CONNECTED), "Protocol version" (00.02.00), and "CU login state" (OK).

**CU STATE**

CU address: 10.10.3.34:9999  
CU connection: CONNECTED  
CU state: CU is RUNNING (0x20)  
Protocol version: 00.02.00  
User password enabled: True  
Login state: OK

**Settings**

IP of iNELS CU: 10.10.3.34  
Password: .....  
ASCII port (optional):  
IP of IMM Server: 192.168.88.55  
Machine ID: 1224b1e5dc751f937263b45541a12439  
Licence key: 612bdf592b1e0d69

update Check iNELS3 CU



b) Upload or edit export.pub

This menu is used for the upload export.pub file from the IDM program to the Connection server and to manually edit elements in web browser.

### Edit export

```

SA3-06M_RE5_000020 R B 16908293 .0 BOOL PUB_INOUT
SA3-06M_RE5_000020_ON R B 16908293 .0 BOOL PUB_INOUT
SA3-06M_RE5_000020_OFF R B 16908293 .0 BOOL PUB_INOUT
SA3-06M_RE6_000020 R B 16908294 .0 BOOL PUB_INOUT
SA3-06M_RE6_000020_ON R B 16908294 .0 BOOL PUB_INOUT
SA3-06M_RE6_000020_OFF R B 16908294 .0 BOOL PUB_INOUT
DA3-22M_IN1_000021 R B 16842753 .0 BOOL PUB_INOUT
DA3-22M_IN2_000021 R B 16842754 .0 BOOL PUB_INOUT
DA3-22M_OVT-ALERT1_000021 R B 17235969 .0 BOOL PUB_INOUT
DA3-22M_OVLO-ALERT1_000021 R B 17235970 .0 BOOL PUB_INOUT
DA3-22M_OVT-ALERT2_000021 R B 17235971 .0 BOOL PUB_INOUT
DA3-22M_OVLO-ALERT2_000021 R B 17235972 .0 BOOL PUB_INOUT
DA3-22M_OUT1_000021 Y B 17039361 REAL PUB_INOUT
DA3-22M_OUT1_000021_ON Y B 17039361 .0 BOOL PUB_INOUT
DA3-22M_OUT1_000021_OFF Y B 17039361 .0 BOOL PUB_INOUT
DA3-22M_OUT2_000021 Y B 17039362 REAL PUB_INOUT
DA3-22M_OUT2_000021_ON Y B 17039362 .0 BOOL PUB_INOUT
DA3-22M_OUT2_000021_OFF Y B 17039362 .0 BOOL PUB_INOUT
DA3-22M_TIN_000021 Y B 17104897 REAL PUB_INOUT
IM3-80B_IN1_000022 R B 16842755 .0 BOOL PUB_INOUT
IM3-80B_IN2_000022 R B 16842756 .0 BOOL PUB_INOUT
    
```

Change to "List of components in export"

! Function for upload export.pub is only for iNELS2 central unit.

! The central unit iNELS3 will download export automatically when you press the Load iNELS3 export button.

i In list we can add and remove elements manually.

- **Bookmark System**

In the System tab, you can reset the network settings, or restart or completely shut down using the "Shutdown" Connection server button.

In the **Network settings** menu, you can set the IP address of the Connection Server. The options are to assign an address from the DHCP server or manually set the static IP address.

We recommend that you set a static IP address so that it does not change if the DHCP server is reset

! By setting the static IP address, the DHCP server will deactivate the IP address assignment and the IP address will be set according to the user settings. Network IP address information.

! If you are using a dynamic IP address from the DHCP server set the router to always allocate the same IP addresses based on the MAC addresses.

In the **Data and time settings** menu - displays the system time to check and adjust the time.

In the **Change Password** menu - change the password.

In the **Edit password** menu (remote control - setting and editing the heating plans in the application).

Other settings in the menu:

The screenshot shows a web interface with the following sections and callouts:

- Update server:** Callout: "Redirected to an update server to update the server." (points to the Update button)
- Shutdown server:** Callout: "Button Shutdown you can remotely shutdown Connection server from Web interface." (points to the Shutdown button)
- Restart server:** Callout: "Button Restart you can remotely restart Connection server from a Web interface." (points to the Restart button)
- Restart server regularly:** Callout: "Set the scheduled reboot of the ServerConnection at a specified time of the week." (points to the time selection area)
- Restart server regularly (fields):** Callout: "Set the minute, hour and day of the week" (points to the dropdowns for minute, hour, and day)
- Restart server regularly (actions):** Callout: "Delete settings" (points to the Delete button) and "Save settings" (points to the Set button)
- NFS Server Configuration:** Callout: "Button Update refresh NFS sharing settings in the file /etc/fstab" (points to the Update button)
- Warning:** A red callout box states: "⚠ To re-start, disconnect and reconnect the micro USB power connector to the Connection Server."

- **Bookmark Media**

The tab is only available for RPI from version 3. The **Settings** section is taken from iMM. The **NAS** section is used to enter the IP address for the **NAS**. When selecting the manual option, a user option is inserted instead of the IP address e.g.:

**MANUAL\_SYNOLOGY\_NFS:**

IP\_ADDRESS/volume1/Storage /mnt/nfs nfs nouser,atime,auto,rw,dev,exec,suid 0 0

**MANUAL\_QNAP:**

IP\_ADDRESS/Storage /mnt/nfs nfs nouser,atime,auto,rw,dev,exec,suid 0 0

**MANUAL\_QNAP\_SMBCIFs:**

IP\_ADDRESS/Storage /mnt/smb cifs username=,password=,nofail,x-systemd.automount,x-systemd.requires=network-online.target,x-systemd.device-timeout=1 0

**MANUAL\_NFS:**

IP\_ADDRESS/Storage /mnt/nfs add parameters

**MANUAL\_SMB:**

IP\_ADDRESS/Storage /mnt/smb add parameters

LMS is available on port 9000, as well as in iMM.

**NAS**

Select NAS:  Select the type of sharing with NAS

Path: **[IP address]** / **[Folder]** /mnt/nfs nfs nouser,atime,auto,rw,dev,exec,suid 0 0

IP address:

Folder:

---

**Settings**

Squeezebox server:

Absolute path to Music directory for squeezebox server:

Squeezebox server username:

Squeezebox server password:

Sonos - SMB IP:

Sonos - SMB music folder:

Set up a path to music files

• **Spotify**

Used to set the bridging of streaming audio from Spotify to LARA devices.  
The CS will be visible in the Spotify Application as a Spotify Connect device where audio can be played.  
This service is only available to users with Spotify premium accounts.

The screenshot shows the 'Spotify' configuration page. It includes a 'Label' field with the value 'Conn-Server', a 'Server IP address' field with '192.168.88.109', and a 'LARA IP address' list with five entries, the first two being '192.168.88.245' and '192.168.88.60'. Below these is an 'update' button and a note: '\* For apply Label changes make reboot.' The bottom section, 'Spotify services', shows three services all set to 'active', with 'enable' and 'disable' buttons below them.

Callouts in the image provide the following information:

- The name that will be displayed in the Spotify application for the newly available Spotify Connect device (points to the Label field).
- CS IP address - is automatically filled (points to the Server IP address field).
- Ability to enable or disable the service on CS (points to the Spotify services section).
- Activation / deactivation Spotify Connect to CS (points to the enable/disable buttons).

- Label - the name change only takes effect after Reboot CS.
- Server IP address - check the correct IP address entry, if the IP address is not entered correctly, LARA cannot play the stream!
- LARA IP address - up to 5 IP addresses can be entered.

• **Bookmark HA-BUS**

Bookmark HA-BUS can be used for interconnection of iNELS3 BUS and a decentralized control system KNX/EIB, which allows control from the iHC app. You can add more iNELS3 central units in this folder.

*In the last hardware revision of Raspberry Pi 3 it is possible to add up to 8 iNELS3 central units*

**Requirements for interconnection with KNX / EIB:**

- KNX Router
- Export group addresses from the program ETS3 – 5

In iNELS3, enter the IP address of the iNELS3 central unit, the password (optional) and a note; adding is completed with the Add button.

Once added, the export is downloaded automatically from the central controller and the prefix "inels3" is added. The last character of the prefix (A-H) specifies the insertion order for the resolution between the central units.

The screenshot shows the 'iNELS3' configuration form. Callouts include: 'IP address of the CU3 central unit' pointing to the 'IP of iNELS3 CU:' field; 'Enter the communication port' pointing to the 'ASCII port:' field (value: 1111); 'Name of CU3 added' pointing to the 'Note:' field; 'Adds the configured CU3' pointing to the 'Add' button; 'Name – configuration in IDM' pointing to the 'Password:' field; and 'Displays the current status of the set CU3' pointing to the 'Check iNELS3 CU' button.

Below the form is a table with callouts: 'Example of Prefix' pointing to the 'Prefix' column; 'Prefix inels3A' pointing to the value 'inels3A'; 'IP address CU' pointing to the 'IP address' column; 'User note' pointing to the 'Note' column; 'Reset the export of the selected CU' pointing to the 'reload iNELS3\_export (is3)' button; and 'Remove CU from the list' pointing to the 'Remove' button.

Prefix	IP address	ASCII port	Note	
inels3A	192.168.88.57	1111	House	is3

For KNX / EIB, the KNX the Gateway must also be filled in. Where you can enter the IP address of the gateway KNX router and save by using the Save button. Then, select the group address export file (see KNX export group address) and export.

The Export group addresses are done in accordance with the ETS format: 1/1 (Name / Add.) Separate each of them by using semicolons.

Before inserting the export it need to be more adapted behind the semicolon refill data type according element values (True, False, 0-255, 0-100) see. KNX DPT link.

Is used to set pairs of KNX device and CU3 device, which will synchronize with each other.

The screenshot shows the 'KNX - CU3 synchronization' interface. Callouts include: 'KNX element selection' pointing to the 'KNX device:' dropdown menu; 'Selecting an element from the central unit' pointing to the 'CU device:' dropdown menu; and 'List of created pairs' pointing to the table below.

KNX device	CU device	
knx_Luster	inels3A_SA3-06M_RE4_000020	Remove

Example export group addresses from ETS:

Example of data in a supplemented file Test\_group.csvs:

```
"Group name";"Address"
Dimming;0/-/-
New Middle Group;0/0/-
Dim A;0/0/1;5
Dim B;0/0/2;5
Switching;1/-/-
New Middle Group;1/0/-
D;1/0/0;1
switch A;1/0/1;1
switch BCD;1/0/2;1
Shutters;2/-/-
New Middle Group;2/0/-
Shutters1;2/0/1
Shutters2;2/0/2
Sensors;3/-/-
New Middle Group;3/0/-
Temperature;3/0/9
```

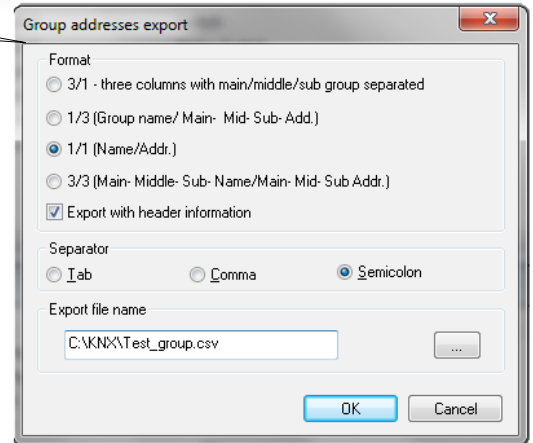

A switch in example; 1/0/1; 1 has value as shown in Table 1 behind a semicolon (True, False) means that a switch.

Data type	Data	Type	Value
1	1 bit	bool	True   False
5	8 bit	num	0-255
5.001	8 bit	num	0-100
6	8 bit	num	-128 +127
232	3 byte	num	RGB [0,0,0] - [255,255,255]

On the Configurations tab, make sure the export listing contains the KNX elements. If so, in the Rooms tab, paste the KNX elements into the selected room. Put the KNX elements into the room in the same way as the iNELS3 elements, the KNX devices have a knx\_ prefix.

! This manual describes the interconnection of iNELS3 and KNX systems, not the KNX element settings.

! If the central unit does not have a password set, leave the insertion field blank.

i Names of elements in the room without the prefix will be converted automatically.

• **Bookmark RF Configuration**

For communication between wireless RF devices and the Connection server an eLAN-RF-003 or eLAN-RF-Wi-003 smart box is required. Enter the eLAN-RF IP address.

! RF elements are assigned to eLAN-RF via the iHC-MAIRF application or via the eLAN-RF web interface (see the iHC-MAIRF manual)

For authorization purposes on eLAN-RF, input boxes are for username and password. Click the **Apply changes** button to reset the process and apply the changes.

! For control of RF elements enable in the iHC-MA, iHC-TA settings.

• **Bookmark Logging**

RF logging for logging changes on RF eLAN. You can add more eLAN-RF or eLAN-RF-Wi.

After adding eLAN-RF, click **Apply changes** to show changes. After loading elements from eLAN-RF, you can select an element, name it and add it to the monitored elements. **Apply changes again. Data from the tracked item can be downloaded via Download or deleted via Clean.**

**CU3 logging for logging changes at CU3.**

You can select an element, name it and add it to the elements you are watching. **Apply changes.** Data at the tracked item can be downloaded via **Download** or deleted via **Clean**. All tracked items can be removed via **Remove all**. The **Download** section also serves for **downloading data**. Wherein, the selected element is referenced along with the time period.



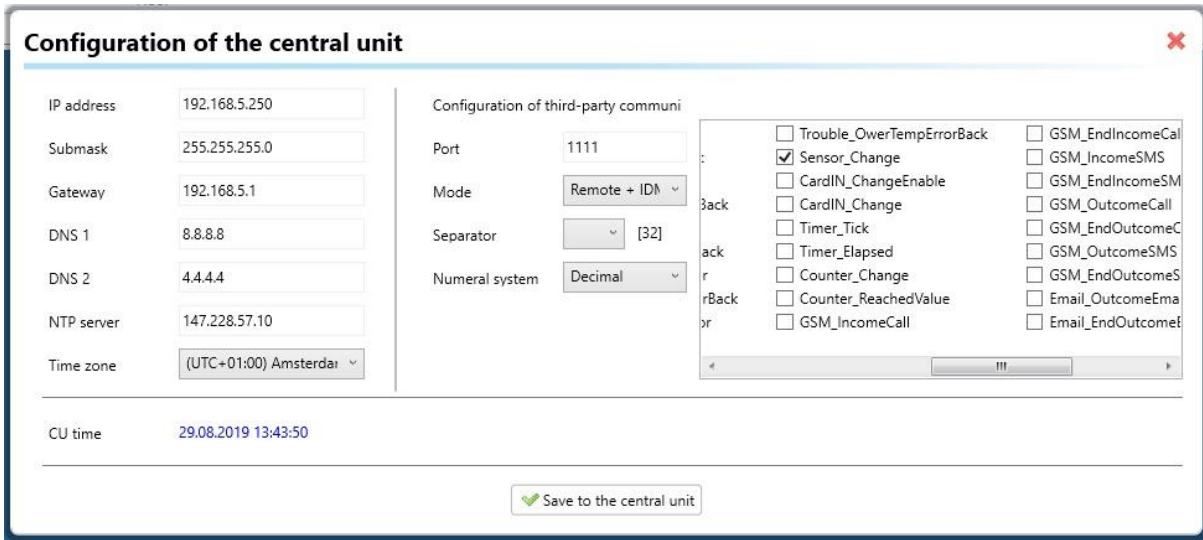

NOTE: property of any monitored device represented in CU3 configuration settings, e.g. Sensor\_Change (e.g. temperature change), has to be checked in order to allow Connection Server logging feature to store required data. All units which uses selected property will provide event data regularly.

• **Bookmark Zones**

Bookmark Zones is used to configure the zones for the Connection server. With the possibility to add multiple zones.

To insert a fill zone name, IP address and choose a zone type change switch to yes.

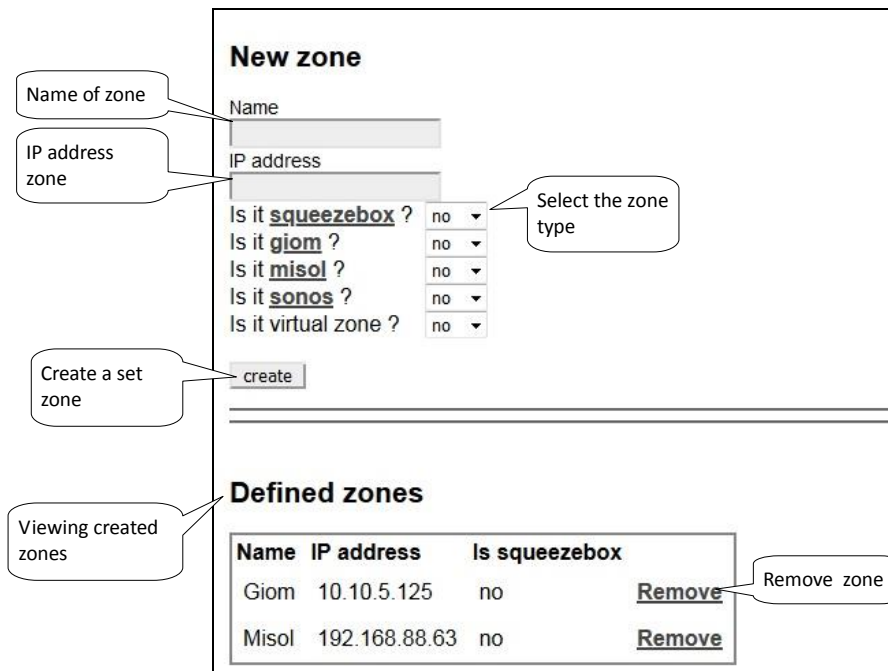

! Connection Server only allows the insertion of GIOM 3000 weather station.

! If you set your password in the GIOM administration, be sure to check Except - status.xml

If GIOM weather station does not show up-to-date measured values (in iHC application or in web-interface of weather station: IP\_ADDRESS\_WEATHERSTATION/status.xml), then it is needed to upload an updated firmware file 2.0.3 which can be found in Partners section at [www.inels.com/partners](http://www.inels.com/partners).

• **EventScript**

In bookmark EventScript creates events, based on which, the pre-set start script. The event is performed if the element reaches the set value of the event. You can use different kinds of elements relay, DAC. Etc.

In menu Triger Rules you can create events, based on which the script runs.

You can select a CU for which you can set a rule. If you enter the IP address of the CU, the **Configuration tab** is displayed by default. If you enter the CU addresses in the **HA Bus** tab, you will be able to select a particular CU, ie **inels3A, inels3B, inels3C**, etc.

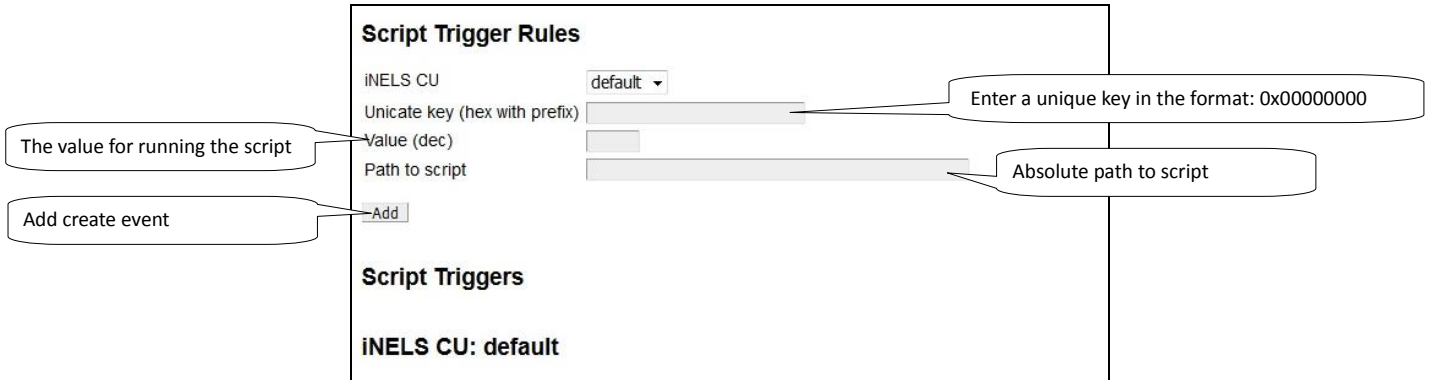

! EventScript uses ASCII protocol, which must be turned on in IDM program, into a free port and in bookmark Configuration in iMM CC insert ASCII port for communication.

Depending on the setting ASCII protocol set value in hex or DEC example. 50 in (HEX) is 80 (DEC).

EventScript run with all device modes (HEX, HEX with prefix and DECIMAL)

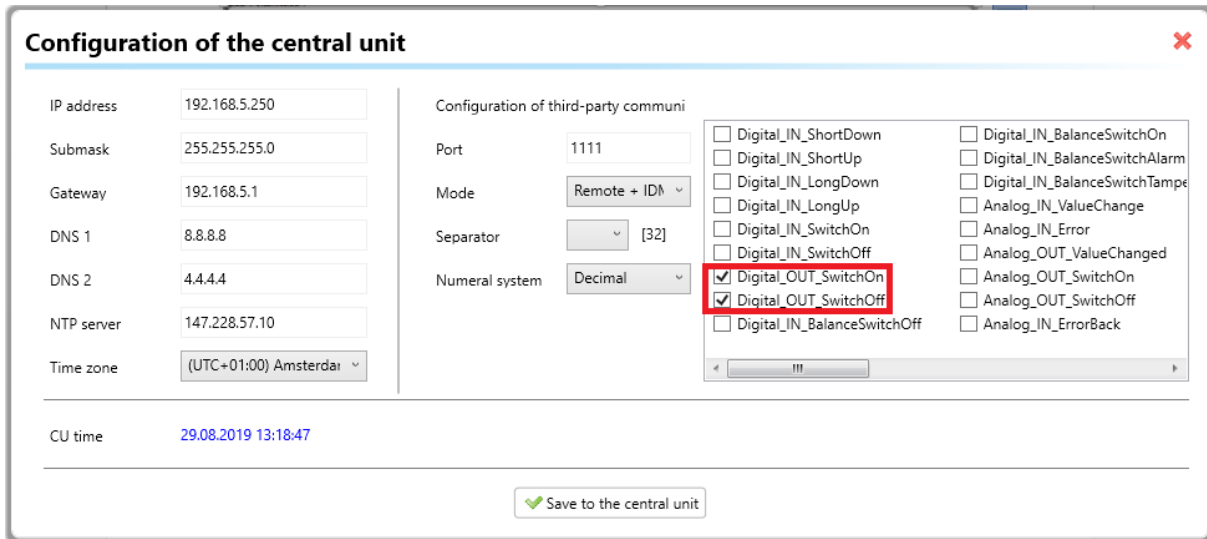

NOTE: properties in CU3 configuration settings (located in iDM), more precisely DIGITAL\_OUT\_SwitchOn and DIGITAL\_OUT\_SwitchOff (system bits belong to digital outputs), have to be checked in order to allow sending script trigger represented by changing of system bit state.

**Tracking Element Value in Script:**

To see the value of the element, insert "?" in the Value field, and then read it through the sys.argv [0] system with argument 0. The script will run periodically after 5 seconds, and the script will respond to the changing value of the variable.

**Reading the value of the element in the script:**

To read the value of the element, insert "?" in the Value field, and then read it through the system sys.argv [0] with argument 0. The script will run periodically after 10

seconds and dynamically respond to changes in the element's value based on logic in the script. This function can be used, for example, to start the heat recovery depending on the temperature of the sensor.

When setting the air conditioner trigger, the event is triggered when the element state changes from 0 to 1.

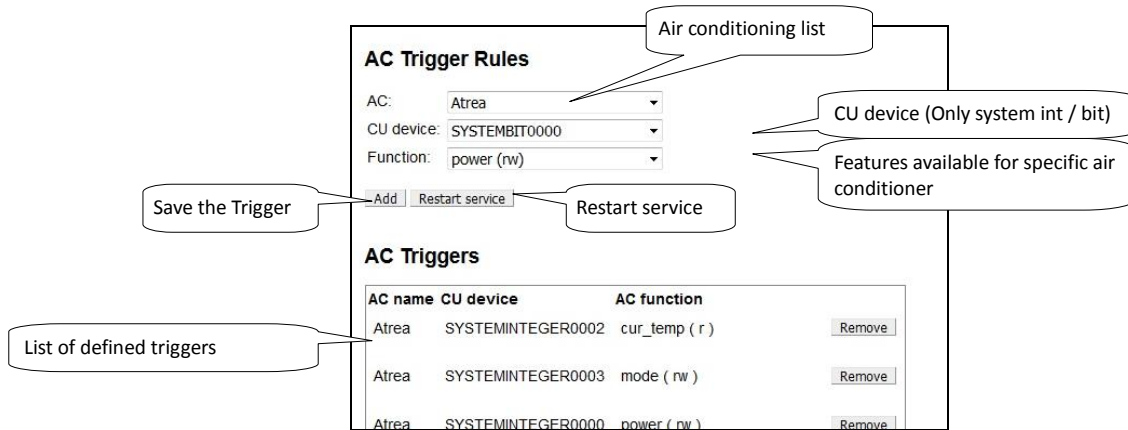

**AC Trigger Rules** used to pair the CU element and AC function. This way you can store AC states to CU and control AC from CU.

**AC:** selects the assigned unit.

**CU device:** select the element you want to assign to that AC function.

**Function:** select the air conditioning function.

Description of AC Features:

- power (rw) - 0 and 1 can be used to monitor whether AC is on, with AC enabled (outside Area - 0-100 range)
- on / off (t) - turns on / off when changing from 0 to 1
- set\_temp (rw) - to monitor the desired temperature in AC with the option to set the temperature
- increase / decrease\_temp (t) - change from 0 to 1 to increase / decrease the temperature by 1 ° C
- cur\_temp (r) - to monitor the current temperature in AC
- mode (rw) - to monitor the current mode in AC with the option to set the mode
- control mode (rw) – to monitor the current control mode with the option to set it
- ventilation\_with\_timeout (w) - set the ventilation for the desired time (in minutes), after the set time elapses, the AC returns to its original state
- heating season (rw) – to monitor whether the heating season is set up

Feature Types:

- (r) - AC reading only and CU write
- (w) - only write status from CU to AC
- (rw) - bidirectional write (combination (r) and (w))
- (t) - a trigger that composes to execute specific functions (activation is performed when the CU element state changes from 0 to 1)

Note: AC write is only done when the CU element state changes.

## Control and read AC status via CU

Working with **mode / fan speed / control\_mode** works with tables below that match the numeric value and **mode / fan speed/ control\_mode**.

### Mode:

Value	Mode
0	unsupported
1	unknown
2	off
3	auto
4	heating
5	cooling
6	ventilation
7	dry
8	periodic_ventilation
9	periodic
10	night_precooling
11	balancing
12	overpressure
13	service

### Supported Modes for Individual AC:

AC	Mode
LG	auto, heating, cooling, ventilation, dry
CoolMaster	auto, heating, cooling, ventilation, dry
Atrea	off, auto, ventilation, periodic_ventilation, periodic, night_precooling, balancing, overpressure
Intesis	auto, heating, cooling, ventilation, dry
Nilan	off, auto, heating, cooling, service
AirPohoda	unsupported
Universal	off, heating, cooling
Daikin	auto, heating, cooling, ventilation, dry
Mitsubishi	auto, heating, cooling, ventilation, dry
Cairox	unsupported

**Fan speed:**

Value	Fan speed
0	unsupported
1	unknown
2	off
3	auto
4	level_1
5	level_2
6	level_3
7	level_4
8	level_5
9	level_6
10	level_7
11	level_8
12	level_9

**Supported speeds for each AC:**

AC	Fan speed
LG	auto, level_1, level_2, level_3
CoolMaster	auto, level_1, level_2, level_3, level_4
Atrea	unsupported
Intesis	auto, level_1, level_2, level_3, level_4, level_5, level_6, level_7, level_8, level_9
Nilan	off, level_1, level_2, level_3, level_4
AirPohoda	unsupported
Universal	unsupported
Daikin	level_1, level_2, level_3
Mitsubishi	auto, level_1, level_2, level_3, level_4
Cairox	auto, level_1, level_2, level_3

**Set / Cur temp:**

For temperatures, a multiple is used to maintain accuracy 100:

$$\text{temp} * 100 = 21,50 * 100 = 2150$$

**Control mode:**

Value	Control mode
0	unsupported
1	unknown
2	manual
3	auto
4	temporary

**Supported control modes for each AC:**

AC	Control mode
LG	unsupported
CoolMaster	unsupported
Atrea	manual, auto, temporary
Intesis	unsupported
Nilan	unsupported
AirPohoda	unsupported
Universal	unsupported
Daikin	unsupported
Mitsubishi	unsupported
Cairox	unsupported

**Direction:**

Value	Direction
0	unsupported
1	unknown
2	auto
3	swing
4	position_1
5	position_2
6	position_3
7	position_4
8	position_5
9	position_6
10	position_7
11	position_8
12	position_9

Supported slat directions for each AC:

AC	Direction
LG	unsupported
CoolMaster	unsupported
Atrea	unsupported
Intesis	unsupported
Nilan	unsupported
AirPohoda	unsupported
Universal	unsupported
Daikin	swing, position_1, position_2, position_3, position_4, position_5
Mitsubishi	auto, swing, position_1, position_2, position_3, position_4, position_5
Cairox	unsupported

- **Bookmark A/C**

Used to define the air-conditioning or heat recovery by third parties and their control through the iHC application.

**Supported are:**

- LG Clims
- Coolmaster, CoolMasterNet
- Air Pohoda
- Atrea
- Universal 0-10V

LG Clims via PI-485 eLAN-RS485/232 or Advantech Adam 4571



CoolMaster series 1000D, 2000S, 3000T, 4000M, 6000L, 7000F, 8000HM, 9000M, CoolMasterNet over Advantech Adam 4571



**CoolMasterNet**

- |                |                                       |
|----------------|---------------------------------------|
| Daikin (DK)    | Mitsubishi Electric (ME)              |
| Fujitsu (FJ)   | Mitsubishi Heavy (MH)                 |
| Gree (GR)      | Panasonic(PN)                         |
| Hitachi (HT)   | Samsung (SM)                          |
| Intensity (MD) | Sanyo (SA)                            |
| Kentatsu (KT)  | Toshiba(TO)                           |
| LG (LG)        | Trane (TR)                            |
| Midea (MD)     | Compatibility: indoor, outdoor units. |

**Others:**

- Atrea Duplex 180 EC4 P (0-10), Duplex 180 EC4 P (0-100)
- AiRPohoda by Adam 4571
- Universal 0-10V by DAC 0-10V





**ADAM-4570\_4571**

RS-232 Pin order

Pin. No.	Description
Pin 1	DCD
Pin 2	Rx
Pin 3	Tx
Pin 4	DTR
Pin 5	GND
Pin 6	DSR
Pin 7	RTS
Pin 8	CTS
Pin 9	RI

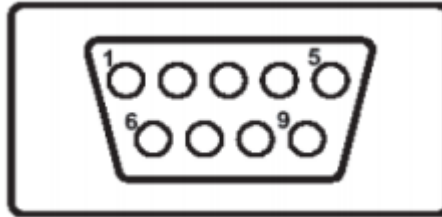

RJ-48 Pin order - RS-422

Pin. No.	Description
1	Tx -
4	Tx +
5	GND
7	Rx +
9	Rx -

RJ-48 Pin order - RS-485

Pin. No.	Description
1	Data -
4	Data +
5	GND

**a) LG Climate control**

It is used to define air conditioning and control it through the iHC application. Supported communication card for LG air conditioner is PI485. The air conditioner must be connected via an eLAN-RS485/232 or Advantech Adam 4571.

**LG clim**

Name  Set name air-conditioning

Type  Select type of communication gateway

Connection (ip\_address:port)  Set IP address and port

Group  Select group

Unit

Save settings Select number air conditioning

## b) CoolMaster

Is used to define air conditioning via the Coolmaster universal control unit and control it through the iHC application.

First step:

First, set the Coolmaster control unit according to the manufacturers manual. (Usually via DIP switches inside the unit) Setup converter LAN-serial485 (Recommended converter: Adam 4571) according to the Coolmaster manual and connect the converter to the CoolMaster control unit.

Test communication:

If the air conditioner control unit is properly connected to the Coolmaster the display alternatively displays the temperature and mode.

Second step:

Moving on to set the air conditioner in the web interface <http://localhost:8080/clims> and fill name and IP address of the convertor and press the Save button, the settings wait for UID to load the air conditioning in system. Now you can select the number of units and save the CoolMaster unit.

**!** If unsuccessful use the reload button and check the air conditioning loaded UID communication converter with the Coolmaster according to the manual

For older Coolmasters version is necessary to set convertor to appropriate port:

Coolmastr type:	1000D, 2000S, 3000T, 4000M, 6000L, 7000F, 8000I(HM), 9000M
Converter:	Adam 4571 nebo Gnome 485      Port: 10001
	CoolMasterNet (default setup)      Port: 10102

Perform the function check via utility ncat command format:      ncat IPADRESA PORT

Example ncat in terminal:

Command	Command	Significance
ncat 10.10.10.111 10102	>	Connection to Cooler Master / Convertor
stat2	000 OFF 25C 27,80C High Heat OK 0	Returns the character command line
		List states Air conditions
		Return state Air condition

For windows you can use SPU (Serial port utility)

**i** Commands and pin setup for cable connection of air conditioning can be found in the reference manual for example: CoolMasterNet

**!** Maximal number of simultaneous connections for CoolMasterNet is 4, only 2 for the Adam 4571 convertor.

## c) Air Pohoda

Used to define air recovery, called Air pohoda and control through the iHC application.

The recuperation must be connected via an eLAN-RS485/232 or Advantech Adam 4571.

d) **Atrea**

Used to define air recovery called Atrea and control through the iHC application.  
New **Duplex EC RD5**. Additionally, you can enter more Atrea units and enter the unit name.

The screenshot shows the 'Atrea' configuration form with the following fields and callouts:

- Name:** [Text input field] - Callout: Enter the name of the unit
- Type:** [Dropdown menu showing 'Duplex 180 EC4.D P(0-10)'] - Callout: Select unit type
- IP address:** [Text input field] - Callout: Enter the IP address of the unit
- Temperature OUT:** [Dropdown menu showing 'VZT - Internal sensor'] - Callout: Outside temperature source for regulation
- Temperature IN:** [Dropdown menu showing 'CP - CP-Touch'] - Callout: Internal temperature source for
- save Atrea** [Button] - Callout: Internal temperature source for

Indoor Temperature Sources:

- CP - The indoor air temperature is measured by a sensor built into the CP-Touch controller
- The T-ETA - indoor air temperature is measured by a sensor built into the unit on the exhaust air outlet
- TRKn - indoor air temperature is measured by sensor connected to RD5-K module (optional unit with RD5 control unit)
- CU - indoor air temperature is supplied by the superior system (central unit)

Outdoor Temperature Sources:

- HVAC - Internal sensor - The outdoor air temperature is measured by the unit's internal sensor
- CU - outdoor air temperature is measured by superior system (central unit)

e) **Universal 0-10V**

Used to define universal air conditioning using DAC 0-10 V and control through the iHC application.

The screenshot shows the 'Universal 0-10 V' configuration form with the following fields and callouts:

- Name:** [Text input field] - Callout: Set name climatization
- Maximal temperature:** [Text input field] - Callout: Set maximum temperature
- Minimal temperature:** [Text input field] - Callout: Set minimum temperature climatization
- Temperature control:** [Dropdown menu showing 'DAC3-04M\_OUT3\_01013d'] - Callout: Select control over DAC
- Heating:** [Dropdown menu showing 'DAC3-04M\_OUT3\_01013d'] - Callout: Select control over DAC
- Cooling:** [Dropdown menu showing 'DAC3-04M\_OUT3\_01013d'] - Callout: Select control over DAC
- Thermometer:** [Dropdown menu showing 'DAC3-04M\_OUT3\_01013d'] - Callout: Select temperature sensor
- save Universal** [Button] - Callout: Save settings

f) Nilan settings

Used to add Nilan ventilation units connected to the eLAN-RS485/232 via the RS485 interface

Connection server communicates with eLAN-RS485/232 using Ethernet.

The screenshot shows the 'Nilan Settings' web interface. It is divided into two main sections: 'Nilan Settings' and 'Nilan unit'.  
 - In the 'Nilan Settings' section, there is a text input field for 'Connection (ip\_address)' containing 'eLAN-RS485/232'. Below it is a 'save Nilan settings' button.  
 - In the 'Nilan unit' section, there is a 'Name' text input field.  
 - Below the 'Name' field is a 'Device ID' dropdown menu.  
 - Below the 'Device ID' is an 'Actual temperature' dropdown menu with 'T1' selected.  
 - At the bottom of the 'Nilan unit' section are 'reload' and 'save Nilan unit' buttons.  
 Callouts on the left side of the interface:  
 - A callout points to the 'Connection (ip\_address)' field with the text 'IP address eLAN-RS485/232'.  
 - A callout points to the 'Name' field with the text 'Device Name'.  
 - A callout points to the 'Device ID' dropdown with the text 'List of created devices in eLAN-RS-485'.  
 - A callout points to the 'Actual temperature' dropdown with the text 'Selection of input on the Nilan unit to which the current temperature sensor is connected'.

g) Intesis Box

It is used to control air conditioners supported by the Intesis box.

**Name** - Intesis unit name.

**IP address** – field for entering the IP address of the unit

The screenshot shows the 'Intesis Box' web interface. It contains two text input fields:  
 - The first field is labeled 'Name:' and contains the text 'Intesis IMM'. A callout points to this field with the text 'Enter the name of the'.  
 - The second field is labeled 'IP address:' and contains the text '192.168.1.6'. A callout points to this field with the text 'Enter the IP address of the'.  
 Below the input fields is a 'save Intesis Box' button.

- **Bookmark ESS**

It is used to connect security systems (Jablotron, Paradox) with the eLAN-RS485/232 to INELS.

It is possible to establish individual functions of the devices connected to the CU Central Unit when an alarm signal is sent from the individual detectors.

- Security Settings for Jablotron:

The image shows two screenshots from a web interface. The top screenshot is titled "Settings" and contains the following fields: "IP address (eLAN-RS485-232):" with the value "192.168.88.62", "Type:" with a dropdown menu set to "Jablotron", and two buttons: "Save" and "Delete". Callout boxes point to these elements: "Setting the IP address of the converter eLAN-RS485-232" points to the IP address field, "Device type selection" points to the "Type:" dropdown, and "Save / clear device settings" points to the "Save" and "Delete" buttons. The bottom screenshot is titled "Export" and contains the text "Upload export file" followed by a file selection button "Vybrat soubor", a status indicator "Soubor nevybrán", and two buttons: "Upload" and "Delete".

Used to upload an export from a security system. Export is allowed for Jablotron system and only in CSV format.

You can get the correct Export file from the Jablotron system using the official J-link program.

[www.jablotron.com/en/search?q=i-link#files](http://www.jablotron.com/en/search?q=i-link#files)

Defining Triggers for Jablotron Security System:

Trigger is used to trigger a SET or SIGNAL (Trigger type) function that is triggered by the Trigger on change of the selected Detector in the selected Area while the Zone is in the defined state (Check states).

You can select more than one monitored zone status.

To define triggers for running a SET function:

The image shows a screenshot of the "Triggers" configuration page. It includes the following fields: "Area:" with a dropdown set to "Area 1", "Check states:" with a multi-select list containing "READY", "ARMED\_PART", "ARMED", and "SERVICE", "Detector:" with a dropdown set to "Detector 1", "Trigger on:" with a dropdown set to "on", "Trigger type:" with a dropdown set to "set", and "CU3 devices:" with two rows, each containing a dropdown menu and a "Value:" input field. Callout boxes provide instructions: "Select area monitoring (set by security system)" points to the "Area:" dropdown; "Selecting a monitoring state for a given area (using the Ctrl button to select multiple statuses at a time)" points to the "Check states:" list; "Function type selection: set - change the state of the device, signal - set the duration of the signal" points to the "Trigger type:" dropdown; "Selection of the monitored detector" points to the "Detector:" dropdown; and "Selection of the monitored state for which the component overlay feature is to be performed in the Central Unit (CU)" points to the "Trigger on:" dropdown. A "Save" button is located at the bottom left of the form.

When uploading an export, it is no longer necessary to select the section and detector number. Select the export detector.

**Triggers**

Check area states:

Detector:

Trigger on:

Trigger type:

CU3 devices:

CU3 device:  Value:

Defining triggers to start the function of the type of SIGNAL:

**Triggers**

Area:

Check states:

Detector:

Trigger on:

Trigger type:

Signal time [s]:

CU3 devices:

CU3 device:  Value:  Value (signal end):

Set the value of the component when the alarm function is activated

Selection of a component from the CU central unit

Set the duration of the signal

Component set value after alarm time (alarm)

List of pre-defined triggers.

Area: 4	States: READY,OFF	Detector: 10	On: on	Type: set	<a href="#">Edit</a>	<a href="#">Remove</a>
Area: 10	States: ARMED	Detector: 4	On: on	Type: signal	<a href="#">Edit</a>	<a href="#">Remove</a>
Area: 4	States: READY,OFF	Detector: 10	On: off	Type: set	<a href="#">Edit</a>	<a href="#">Remove</a>

- Define the storage state to CU3

Define saving the zone status to CU3 if the zone is in the selected state.

**Save to CU3**

Type: STATE (Select storage type (zone or detector status))

Area: Area 1 (Zone area)

State: READY (Selection of monitored zone)

CU3 device: (UID: 33751040) SYSTEMBIT0000 (Selecting a component from CU3 where to save whether the zone is in the selected state)

Save

Area: 1	State: READY	CU3 Device: (UID: 33751040) SYSTEMBIT0000	<a href="#">Remove</a>
Area: -	Detector: 1	CU3 Device: (UID: 33751042) SYSTEMBIT0002	<a href="#">Remove</a>
Area: 2	State: ARMED	CU3 Device: (UID: 33751041) SYSTEMBIT0001	<a href="#">Remove</a>
Area: 3	State: ARMED	CU3 Device: (UID: 16908293) SA3-06M_RE5_000020	<a href="#">Remove</a>
Area: -	Detector: 2	CU3 Device: (UID: 33751043) SYSTEMBIT0003	<a href="#">Remove</a>
Area: -	Detector: 3	CU3 Device: (UID: 16908294) SA3-06M_RE6_000020	<a href="#">Remove</a>

List of pre-defined states of CU3

Defining the storage status of the detector in CU3.

**Save to CU3**

Type: DETECTOR (Select storage type (zone or detector status))

Detector: Detector 1 (Detector selection)

CU3 device: (UID: 33751040) SYSTEMBIT0000 (Selecting a component from CU3 where to store the)

Save

Area: 1	State: READY	CU3 Device: (UID: 33751040) SYSTEMBIT0000	<a href="#">Remove</a>
Area: -	Detector: 1	CU3 Device: (UID: 33751042) SYSTEMBIT0002	<a href="#">Remove</a>
Area: 2	State: ARMED	CU3 Device: (UID: 33751041) SYSTEMBIT0001	<a href="#">Remove</a>
Area: 3	State: ARMED	CU3 Device: (UID: 16908293) SA3-06M_RE5_000020	<a href="#">Remove</a>
Area: -	Detector: 2	CU3 Device: (UID: 33751043) SYSTEMBIT0003	<a href="#">Remove</a>
Area: -	Detector: 3	CU3 Device: (UID: 16908294) SA3-06M_RE6_000020	<a href="#">Remove</a>

When uploading an export, it is no longer necessary to select the section and detector number. Select the export detector.

**Save to CU3**

Type: DETECTOR

Detector: Akustický Detektor rozbití skla P6

CU3 device: (UID: 16908411) Controller\_Window-Detector-DIN\_01296B

Save

Area: -	Detector: Bezfázový dvouzónový PIR P10	CU3 Device: (UID: 16908290) SA3-06M_RE2_000020	<a href="#">Remove</a>
---------	--	--	------------------------

- Paradox security system settings

The Paradox setting is the same as the Jablotron setting. They differ only in the type of zone status.

• **Bookmark Rooms**

Bookmark Rooms is used to configuration of the rooms.cfg, for loading the iHC application (more information in the iHC manual). Rooms are actually "virtual rooms" (groups), which have the option to group the icons and zones for one or more screens.

First enter the room name, save it with the **Add** button.

! Only A-Z, a-z, 0-9, -, \_ can be used for the room name.

Using the **upload** and **download** buttons, you can download or record the rooms.cfg (bookmark of the already created rooms).

**New room**

Set name of room: Name [input field]

Set password for room: Protect by password

Create Room: Add

File upload: Upload

Download File: Download

Saved room: [input field]

Remove selected room: [Remove]

Edit room: Edit

Set the room password: Set password

Rename Room: Rename

Using the Edit command, the menu adds the desired devices (scenes, zones ...) to the room.

**Add new device**

Select Type: Type [airing]

Select the row and column: Name [hall1], Column [2]

Recommended length of "Name" is 8 characters. If the length is longer then it does not display correctly.

Attributes: device: Controller\_Actual-Ther

Select specific device: Controller\_Actual-Ther

Switch Icon read only yes/no: read only: no

Add device: Add

View saved devices: [Table]

Row	Name	Type	Column	Attributes	Action
1	hall1	lamp	1	device: SA3-06M_RE1_013AB9	DOWN REMOVE
6	hall2			absolute path /etc/inm/ShuttersUP.py dev_0 SA3-06M_RE2_013AB9	DOWN REMOVE

Click on the line to display the editing menu

Remove device: [REMOVE]

Move Up or Down device: [UP] [DOWN]

Changing device views: [VIEW]

an optional absolute path to a script that ends with .py or .sh

Thermo meters: No thermo meters defined

Zones: No zones defined

Save settings: Save

Device: RFDA-73MRGB\_Red\_00A8AE

Cancel Confirm



! Device type - the selected icon filters the elements (for example, the Lamp type filters the elements on the dimmers, the scene displays the field for writing the absolute path ...).

! By switching the Read only function to "yes", the icon will display only the status of the non-controllable element.

Adding a device:

Type Device Type, Name, Row / Column. In the Attributes field, select the device you want from the menu.

Attention: the icon must not remain empty without the name and the selected device

Add a scene:

Select a scene in the type. Enter the name, Row / Column. You can use the programmed script to control the scenes, which can trigger various functions defined in it. You must keep an absolute path starting with "/" and ending with the "Python" script that you type in the Attributes field. Multiple elements can be added to the scene.

• **Bookmark Cameras**

Bookmark Cameras is used for defining IP cameras, which you want monitor and control by the iHC application.

The HTTP and RTSP ports are only filled in if you have IP cameras configured to access the external network by redirecting ports to the router or using the ONVIF protocol.

- If you connect the camera remotely over the HTTP port, you get to its web interface and you can fully control the camera.
- If via RTSP, then you only get to the camera stream. For more information on setting these ports, see the manual of the selected camera.

If you do not enter the HTTP and RTSP ports they remain with the defaults of HTTP port 80, RTSP port 554.

Supported cameras: iNELS cam  
 AXIS protocol VAPIX2 cameras with firmware version number 4.0.X.X and VAPIX3 with firmware version 5.0.X.X  
 Camera with ONVIF protocol profile S certification ONVIF link  
 Cameras supporting RTSP stream

In the **New camera** menu, add IP cameras to the Connection server.

Example integration of cam Axis supported ONVIF: connect the camera according to camera manual and create a user for the ONVIF protocol which might be different according to manufacturer. Set the video stream profile: MJPG to MJPEG/JPEG and the second RTSP stream to MPEG4/H264.

**New camera**

Set name for camera	Name	Axis P5534 2	Set IP address camera
	IP address	10.10.5.143	
Set user name	User	OnvifUser	Password
	Password	•••••	
Port for MJPG	Service port	80	
Port for RTSP stream	MJPG port	845	
	RTSP port	5684	
Camera manufacturer	API	Select API	Select an API
	Manufacturer	Axis Communications AB	Camera Type
	Product Name	AXIS M3025-VE Network Camera	
	Firmware version	5.40.5	
The FW version from which the camera manufacturer supports the onvif protocol	Date Certified	8/12/2013	
	<input type="button" value="create"/>	Date Certified	
	Create camera		

**i** The service port is the ONVIF port usually set on port 80. If the camera is behind NAT it is necessary to redirect to the router and this port otherwise the camera cannot be configured

Ports by default:

Axis - ONVIF HTTP port: iHC: 80 RTSP port - iMM: 554 Application support: iHC-MA, TA, Mi, Ti

Other ONVIF cameras HTTP port: iHC: 554 RTSP port - iMM: 554 Mobile stream support via RTSP: only in app. iHC-MA, TA!

In the Select **stream menu**, select the **pre-set streams** on the camera that is assigned to the iHC mobile app.

The **List of cameras** menu displays saved cameras on the Connection Server and allows you to edit or delete the selected camera from the web interface.

If you are creating an ONVIF camera, the next step will offer the stream to select, possibly editing it, or enter it manually. The manual selection will also be offered if the streams are not successfully downloaded from the camera.

Select stream profile for RTSP

manual ▾ load

Stream: rtsp://192.168.1.10:554/

Select stream profile for MJPG

manual ▾ load

Stream: http://192.168.1.10:80/vid

- **Bookmark Miele**

In the menu Miele set the IP address of the Miele gateway device that serves to control remotely appliances over powerline, or ZigBee protocol.

Supported gateways: XGW 2000, XGW 3000 (Firmware 1.1,1.2)

The image shows a screenshot of the Miele configuration interface. The title is "Miele". Below the title are four input fields: "IP:", "E-mail:", "Relay:", and "HDO:". The "Relay:" and "HDO:" fields have dropdown menus with the value "SA3-06M\_RE3\_000020" and "SA3-06M\_RE1\_000020" respectively. At the bottom left is an "update" button. To the right of the "IP:" field is a callout box: "IP address device Miele gateway XGW 2000, XGW 3000". To the right of the "E-mail:" field is a callout box: "E-mail for notice". To the right of the "Relay:" field is a callout box: "Relay for restart GW". To the right of the "HDO:" field is a callout box: "Element Smart grid signal". Below the "update" button is a callout box: "Update settings".

! Set IP address MieleGateWay which is stored in the file `/etc/imm/miele`

! The GW restart relay is used to switch off / on if the gateway loses the network connection and sends the notification to the user's email.

• **Bookmark Intercoms**

In the Intercoms tab, you can specify settings for door intercoms and VoIP accounts for iHC applications.

To create an account for LARA or Mobile, use the **New intercom** account section.

**New intercom account**

Contact name:  New contact name

Account:  SIP name

Secret:  SIP password

Stream:  Streaming video URL of the

Add a new contact

To create a door phone account, use the **New intercom** account (for a door phone) section.

Choice of three types of door intercoms (2N, IP-Bold, Dahua).

**New intercom account (for a door phone)**

Contact name:

Account:

Secret:

Stream:

Door lock URL:  Enter a URL to unlock the lock

Device type:  Choice of sound type

Username:

Password:

Lock code:

For the correct function of calls using iHC applications, it is necessary to assign the highest priority to the PCMU codec in the intercom - 2N (Services / Telephone / Audio / Codecs).

When making a door-to-door contact, it is not limited to one door, more can be entered.

New ability to create groups. Create individual contacts, add them to the group. Make a group call name, the call will be applied to all the contacts in the group, who will receive the first call, who will communicate. Contacts are grouped into the group via the **New intercom group**, where all contacts are inserted and separated by commas: **LARA1, LARA2, LARA3**.

**New intercom group**

Group name:

Accounts:

You can set the maximum ringtone length in the **Asterisk settings** section.

**Apply settings** button activates newly created VoIP accounts and restarts the PBX Asterisk.

**Asterisk settings**

Ring timeout [s]:

**Upload or download intercoms backup**

Upload:

**Update asterisk settings**

In the list of created contacts, which contact is registered on the SIP server is colour-coded.

**Update asterisk settings**

[Apply settings](#)

---

**Intercom accounts**

Contact name	Account	Secret	Stream	Door phone	
Intercom2	Intercom2	asdf		Dahua-VTO2000A	<a href="#">Edit</a> <a href="#">Remove</a> <a href="#">Get 2n config file</a>
Intercom	Intercom	asdf	rtsp://admin.admin@192.168.88.55	Dahua-VTO2000A	<a href="#">Edit</a> <a href="#">Remove</a> <a href="#">Get 2n config file</a>
LARA	LARA	asdf			<a href="#">Edit</a> <a href="#">Remove</a> <a href="#">Get 2n config file</a>
Mobil	Mobil	asdf			<a href="#">Edit</a> <a href="#">Remove</a> <a href="#">Get 2n config file</a>
LARA2	LARA2	asdf			<a href="#">Edit</a> <a href="#">Remove</a> <a href="#">Get 2n config file</a>

[Active](#) / [Unactive](#)

**Intercom groups**

Group name	Accounts	
Office	LARA, LARA2,	<a href="#">Remove</a>

! The connection server allows you to set up a single door intercom via DTMF on the web interface.

i Stream for cam add in format rtsp://IPADRESA.

i Manual link for video intercom the iHC application can be added in the contact intercom field with the IP address in this format:  
<http://IPADRESA/enu/camera640x480.jpg>.

! The connection server allows only one door intercom to be opened on the web interface.

i In the case of multiple 2N IP intercoms, all must be set to green as well (User name, Password, Lock code).

• **Bookmark Energy**

The Energy module allows recording of consumed energy for a day, week, month and year. Consumed energy is displayed in the iHC application not only in a given quantity but also in financial value in the form of a table or graph.

The data is stored on the Connection Server even when the power is off or on.

Energy is recounted based on the amount of impulses that the outputs from meters provide (gas-meters, electrometers, water-meters). Impulses are further processed in an optional input unit of system iNELS (IM2-140M, IM2-20/40/80B) in form of a counter. This value is by means of export.pub transferred to Connection Server where variable is in IMM CC on bookmark Energy assigned to Water/Gas/Electric.

The actual setup conversion of pulses per unit of measure, currency selection and adjustment of the currency / unit is done in the web interface in the Connection Server.

**Connection of electric meter, gas meter or water meter**

The connection of a particular meter is executed via the binary input unit. The polarity of the supported meter, i.e. + and - is distinguished. If necessary, observe the polarity and connect the "-" terminal to the GND terminal and the "+" terminal to the IN terminal.

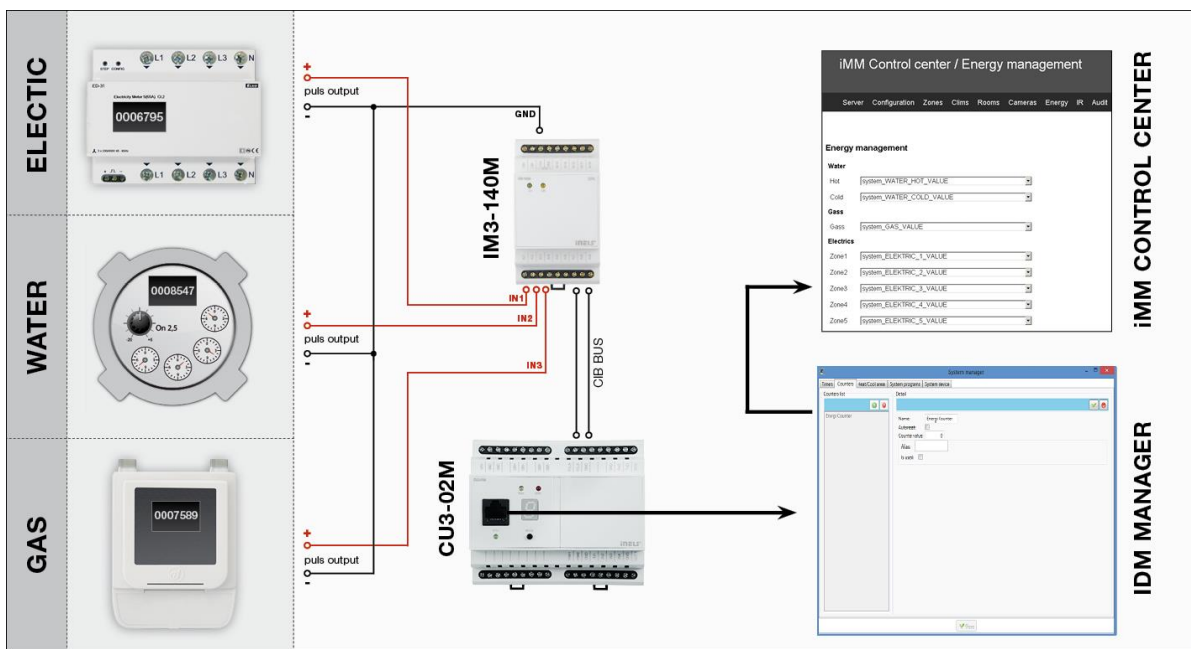

Settings in IDM2:

1. Click on the System Configuration button (icon of hammer and screwdriver – F11)
2. Select bookmark System -> counters
3. Add counter that you name by energy you want to measure
4. Create a new action that you name e.g. upload electricity
5. Add a command in the action which will be user action -> commands for counters -> increment counter
6. Select counter that corresponds with given action (e.g. for upload electricity you put counter electricity)
7. Add the action created as described above in system configuration to relevant binary input in action line when the input closes
8. Once the file export-pub is created and uploaded to IMM server, in bookmark Energy you can assign in the counter value line (electricity\_VALUE). It must be VALUE in the line.

Creation of counter in IDM2:

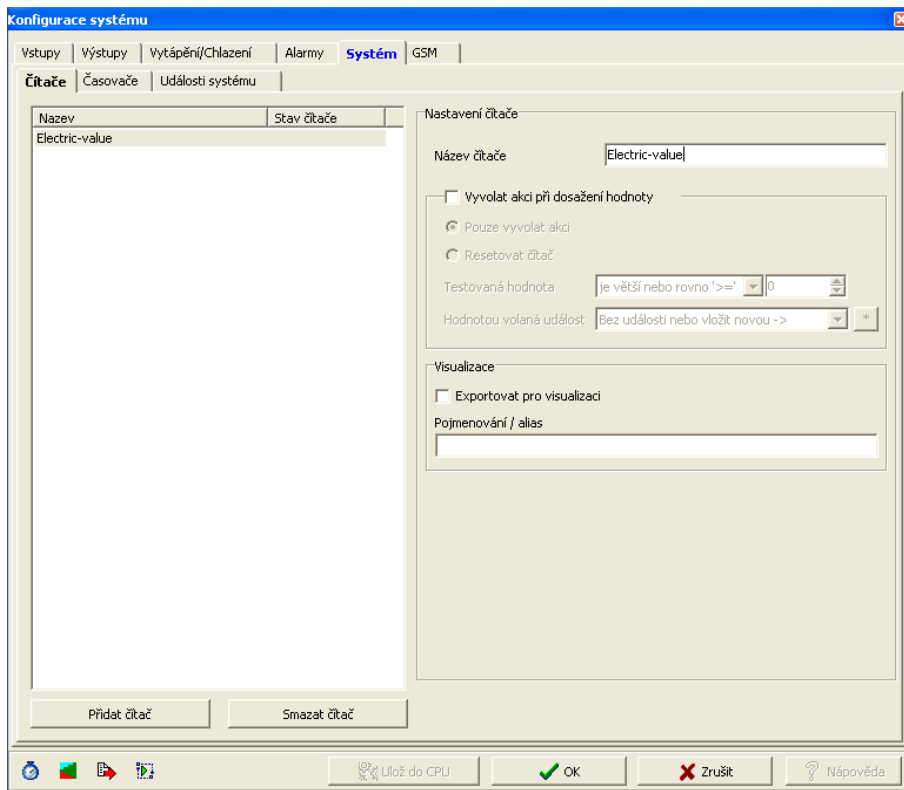

Create increment counter action:

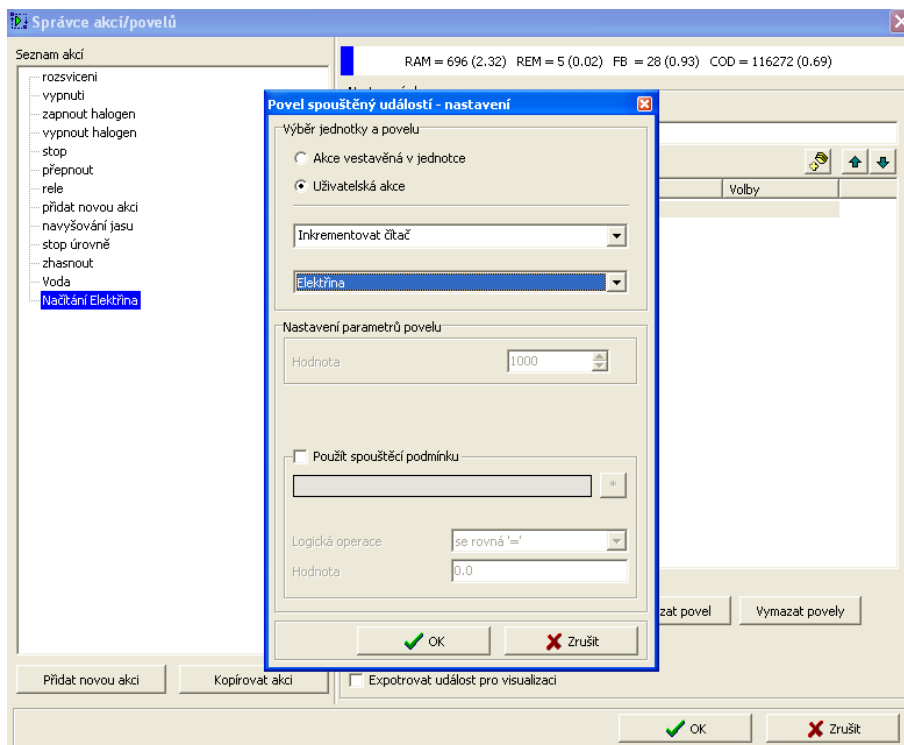

Action assignment to binary input where output from measuring instrument is connected

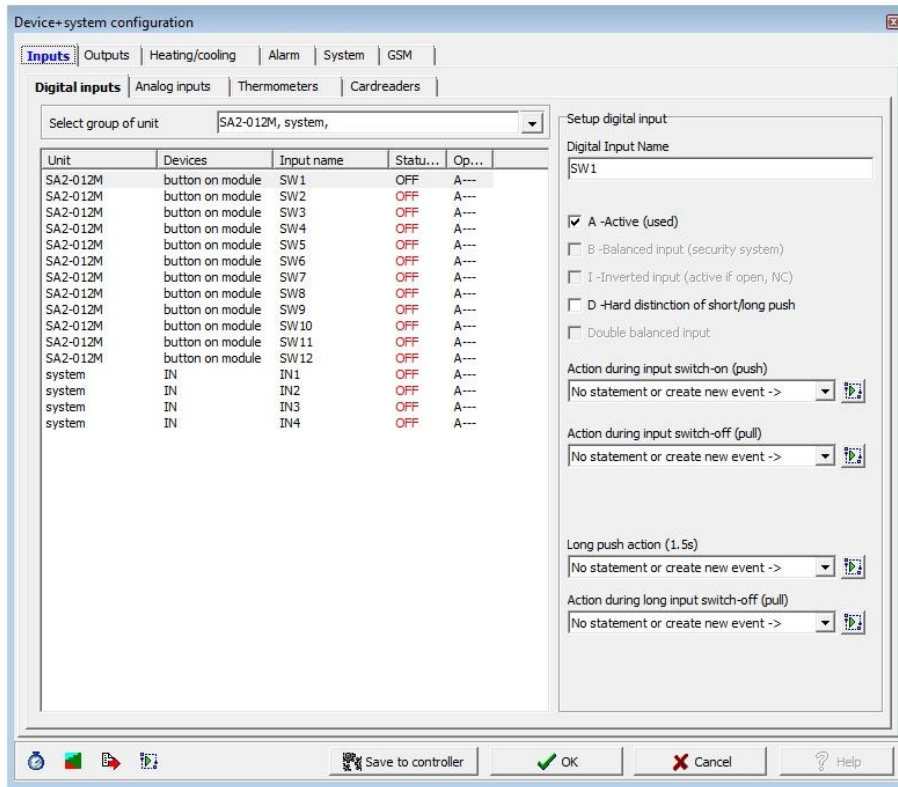

Assign a counter value to the iMM Control Center

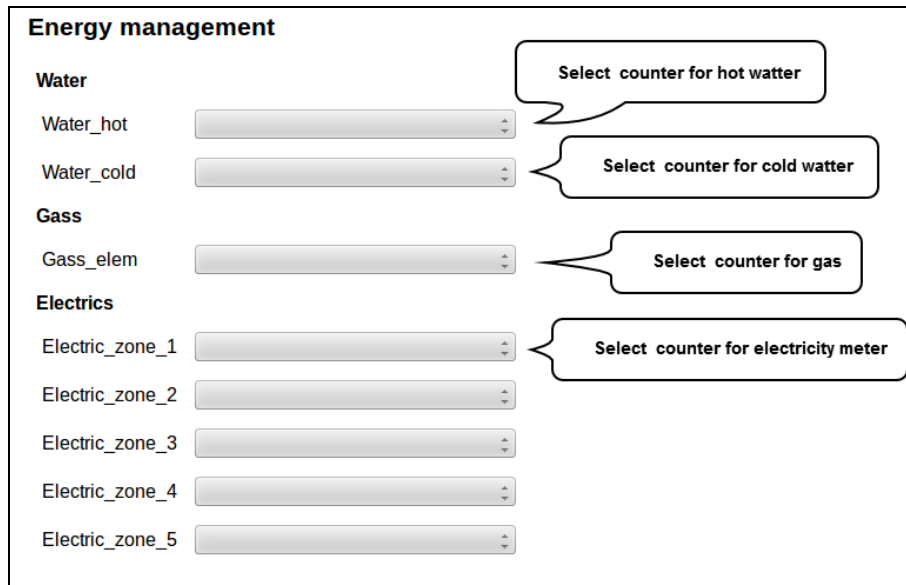

Example:  
 1 kWh = 100,- Kč = 100 pulse  
 Base Unit – kWh  
 Impulses – 100 per 1 kWh  
 Price – 1 per 1 impulse

To create a counter in IDM3, see Create counter IDM3



a) Energy management

In the Energy Management menu, select binary inputs for WATER, GAS, and ELECTRICITY and allocate units and impulses to them.

**Energy management**

**Water**

Water\_hot

Water\_cold

**Gass**

Gass\_elem

**Electrics**

Electric\_zone\_1

Electric\_zone\_2

Select counter for hot water

Select counter for cold water

Select counter for gas

Select counter for electricity meter

**Electric** Label:  custom name

Base Unit:  kWh  MWh  other  Option to enter your own unit

Z1 Price:	<input type="text" value="1"/>	per	<input type="text" value="1"/>	Impulses	per	<input type="text" value="1"/>	E
Z2 Price:	<input type="text" value="1"/>	per	<input type="text" value="1"/>	Impulses	per	<input type="text" value="1"/>	E
Z3 Price:	<input type="text" value="1"/>	per	<input type="text" value="1"/>	Impulses	per	<input type="text" value="1"/>	E
Z4 Price:	<input type="text" value="1"/>	per	<input type="text" value="1"/>	Impulses	per	<input type="text" value="1"/>	E
Z5 Price:	<input type="text" value="1"/>	per	<input type="text" value="1"/>	Impulses	per	<input type="text" value="1"/>	E

For the Z2 meter, the price for the specified number of pulses

The number of pulses set for loading units

Number of units in pulse rate ratio

**Water** Label:  custom name

Base Unit:  l  hl  m3  Gallon UK  Galon US  other  Option to enter your own unit

Impulses:  per  W

Price:  per  Impulses

**Gass** Label:  custom name

Base Unit:  m3  other  Option to enter your own unit

Impulses:  per  G The number of pulses set for loading units

Price for 1 pulse:  per  Impulses

**Currency:**

Choice of currency

To create a counter, see the Energy tab

**b) Creating counters (counters) in IDM3**

Creating a counter in IDM3

Managers tab, select the System Manager and go to the tab Counters where you create a counter name. Click the + icon to fill in the name and "tick" the item **Apply to export**.

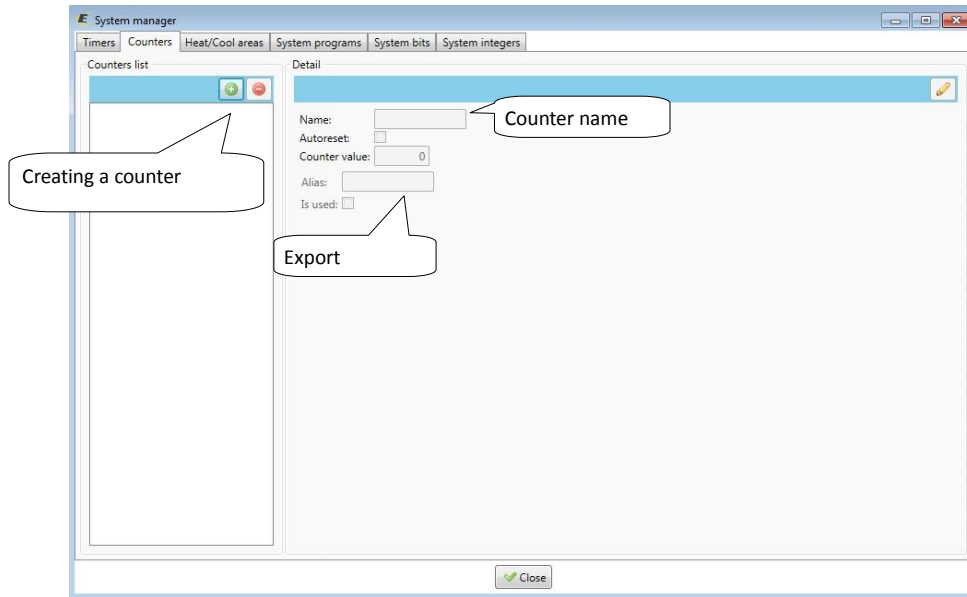

Creating functions for counter

In the **Wires** tab, select the **Function Manager** option. Here you create a function named Energy Increment (the function type is **Counter**).

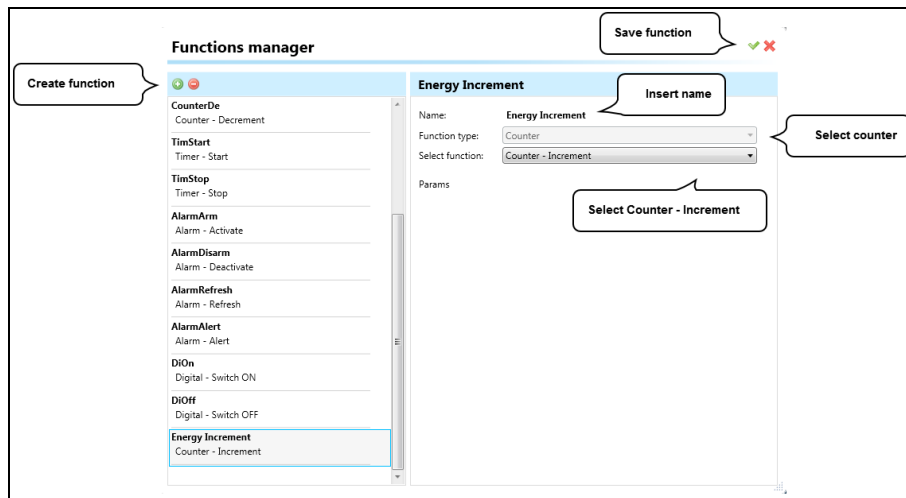

Move the switch and central units to the desktop and double click on switch icon edit and select IN Digital input M3-80B.

In the Function tab, select ADD connections, make the connection by pulling the wire from the switch icon on the icon and select Central Unit Energy.

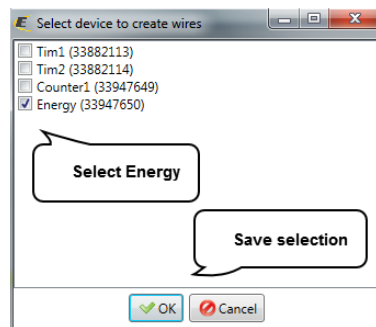

In the tab, Function select Wire Manager, select the input (IN) Energy through button the Edit function to adjust to Action: Short down User function: Energy Increment.

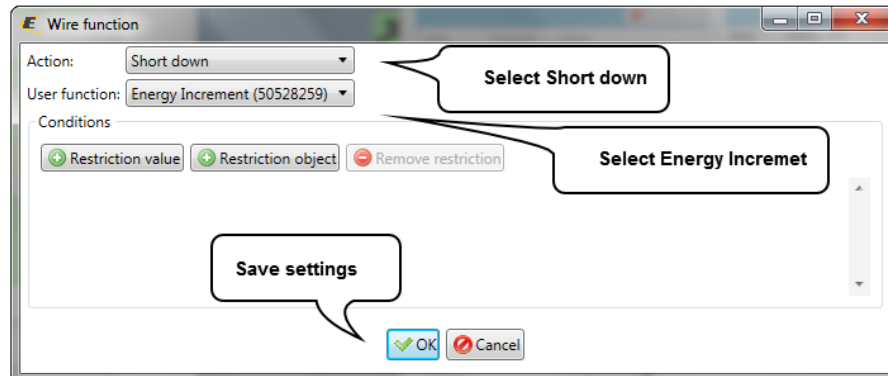
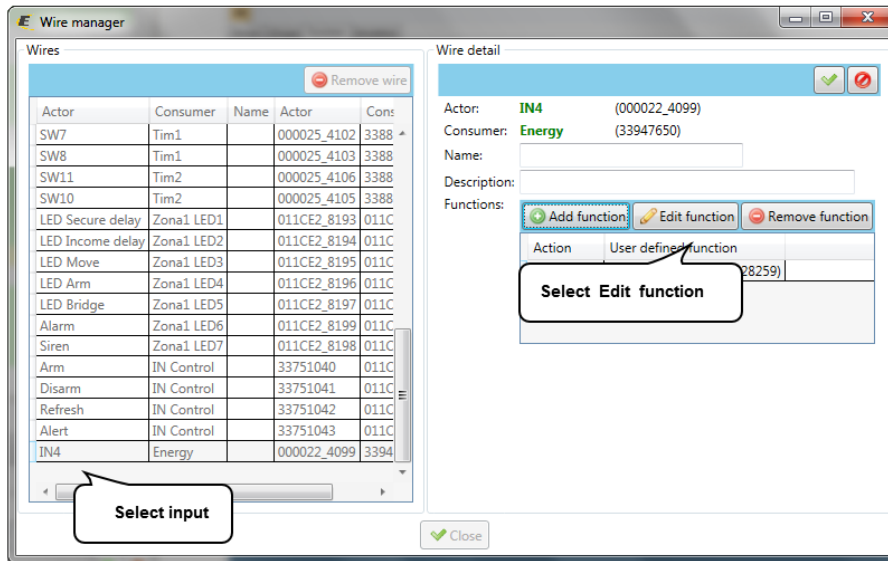

Add the created counter to iMMCC Energy management

### c) Currency

Currency setting option. There is also the option to erase all measured data via the **delete data** button at the bottom of the page.

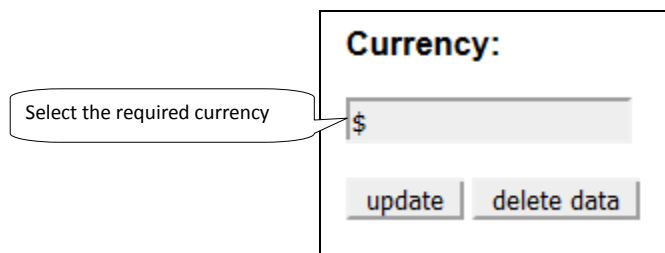

• **Bookmark Weather**

In the Weather tab, you can create scenes or set the data to be copied to the central unit according to the weather station data.

**Giom meteostation**

You can choose whether the scene is called once or periodically (**Triggered**), and whether you want to check if exceeds or falls below the value (**Check value**).

Depending on the values set on the web interface, the scene is performed when the value is greater than or less than the scene setting value

**Giom meteostation**

Perform the scene once or periodically

Check values exceeding / falling below

The selected command is executed when the value is exceeded

Low wind speed

High wind speed

Low temperature

High temperature

Low relative humidity

High relative humidity

Save settings

Save wind speed to: SYSTEMINTEGER0000

Save temperature to: SYSTEMINTEGER0001

Save relative humidity to: SYSTEMINTEGER0003

Restart service

Restart to activate save

It is used to write measured values to CU (wind speed, temperature, humidity)

The selected command is executed when the value falls below

Low wind speed: 2 m/s Triggered: Once Check value: Both Edit: Value is above Value is below

High wind speed: 5 m/s Triggered: Once Check value: Both Edit: Value is above Value is below

Low temperature: 20 °C Triggered: Once Check value: Both Edit: Value is above Value is below

High temperature: 25 °C Triggered: Once Check value: Both Edit: Value is above Value is below

Low relative humidity: 40 % Triggered: Periodic Check value: Below Edit: Value is above Value is below

High relative humidity: 60 % Triggered: Periodic Check value: Above Edit: Value is above Value is below

You can edit the scene in the Edit menu. In the selected scene, you can add or remove relay units.

**low\_temp**

Selected relay

State ON =1 OFF=0

SA2\_04M\_Sn\_SW1

1

Add event

Add relay

**Defined events**

SA2\_04M\_Sn\_SW1 1 Remove

Remove unit

Added switch unit

Connect Giom station as a zone:

IMM connection with the server is defined in IMMControl Center in the "Zones" where it is necessary to state "Is it Giom?" switch from "no" to „yes“.

Settings are made via the web interface. The first time finding of the IP address of the weather station is possible with the software "Mlocator", which can be downloaded from the manufacturer's website.

! For proper function you must first set up Giom as a zone. If you set your password in the GIOM administration, be sure to check Except - status.xml.

Information from weather station can be displayed in the iHC applications or IMM application by pressing the left button on the clock icon at the top right of the application.

**Misol meteostation**

Possibility to configure data from the weather station with components from the central unit.

**Misol meteostation**

Wind direction	Save wind direction to:	SYSTEMINTEGER0000
Temperature	Save temperature to: <sup>1</sup>	SYSTEMINTEGER0001
Humidity	Save humidity to:	SYSTEMINTEGER0002
Wind speed	Save wind speed to: <sup>1</sup>	SYSTEMINTEGER0003
Gust speed	Save gust speed to: <sup>1</sup>	
The amount of precipitation	Save rainfall to:	SYSTEMINTEGER0004
UV value	Save uv to:	
Light intensity	Save light to:	
Low battery indication	Save low battery to:	

<sup>1</sup> Values are multiplied by 100.

Save settings → Save Restart service → Restart to activate saving

Connect Misol station as a zone:

IMM connection with the server is defined in iMMControl Center in the "Zones" where it is necessary to state "Is it Misol?" switch from "no" to „yes“.

Enter the IP address of the eLAN-RS-485/232 converter (with the already configured Misol meteostation device) as the IP address of the weather station.

**i** Information from weather station can be displayed in the iHC applications or iMM application by pressing the left button on the clock icon at the top right of the application.

• **Bookmark Aseko**

Add Aseko pool technology. It is used for monitoring the values and operation of the device.  
Both older and newer versions of Aseko are supported.

**Add Aseko device:**

Facility Name

Name: Aseko

IP address: 192.168.88.100  
ELAN-RS-485 converter IP address (with Aseko device already configured)

Device type: SYSTEMINTEGER000

Automat: SYSTEMINTEGER001

pH<sup>1</sup>: SYSTEMINTEGER002

Cl<sup>1</sup>: SYSTEMINTEGER003

Rx<sup>1</sup>:

Temperature: <sup>1</sup> SYSTEMINTEGER004  
Selection of the system integer from the CU where the value is to be written

Desired pH (NEW): <sup>1</sup>

Desired Cl/Rx (NEW): <sup>1</sup>

Desired temperature (NEW): <sup>1</sup>

Desired clarifying agent (NEW): <sup>1</sup>

Relay states (NEW):

Error 1 (NEW):

Error 2 (NEW):

Error (OLD):

Surface (OLD): <sup>1</sup>

<sup>1</sup> Values are multiplied by 100.

Add Store Aseko devices

**Comment:**

An asterisk next to the name means that the value is multiplied by 100 (e.g.: if the pH is 700 then the real value is 7).

OLD: value only for older Aseko devices

NEW: value is only for older Aseko devices

For more information on the stored values see. eLAN-RS-485/232 manual.

Aseko devices already added:

**Aseko devices:**

Name	IP address	
aseko 1	192.168.88.63	Edit

Possibility to edit or delete devices

- **Bookmark Manual**

In bookmark Download you can download the current version manual in PDF format.

- **Bookmark Default settings**

Bookmark Default settings is used for reset settings to default state.

**Reset all server settings to default** - factory settings (all user settings are deleted).

**Reset all devices dependencies to default** - deletes only user settings and their dependence on other IMM server features.

- **Bookmark Audit**

Bookmark Audit is used to show and download LOG file option events for diagnostic developer purposes.

### Logged events

```
127.0.0.1:49528 - - [02/Jan/2015 13:50:04] "HTTP/1.1 GET /style.css" - 200 OK
127.0.0.1:49528 - - [02/Jan/2015 13:50:04] "HTTP/1.1 GET /favicon.ico" - 200 OK
127.0.0.1:49528 - - [02/Jan/2015 13:50:07] "HTTP/1.1 GET /favicon.ico" - 200 OK
127.0.0.1:49528 - - [02/Jan/2015 13:50:08] "HTTP/1.1 GET /manual" - 200 OK
127.0.0.1:49528 - - [02/Jan/2015 13:50:08] "HTTP/1.1 GET /style.css" - 200 OK
127.0.0.1:49528 - - [02/Jan/2015 13:50:08] "HTTP/1.1 GET /favicon.ico" - 200 OK
127.0.0.1:49528 - - [02/Jan/2015 13:50:09] "HTTP/1.1 GET /favicon.ico" - 200 OK
127.0.0.1:49528 - - [02/Jan/2015 13:50:10] "HTTP/1.1 GET /dsettings" - 200 OK
127.0.0.1:49528 - - [02/Jan/2015 13:50:10] "HTTP/1.1 GET /style.css" - 200 OK
127.0.0.1:49528 - - [02/Jan/2015 13:50:10] "HTTP/1.1 GET /favicon.ico" - 200 OK
```

[Download logs](#) [Download log file](#) [Actual log list](#)

- **Bookmark Logout**

Logout from the web interface.

### 3. Connection Server update server

To update Connection Server firmware, log into web interface (IP\_ADDRESS\_CONNECTION\_SERVER:8080) and move to tab System. Locate part called Update Server and click on button *Update*. It will be forwarded to update server page where user has to fill login credentials again (default one: imm / imm123).

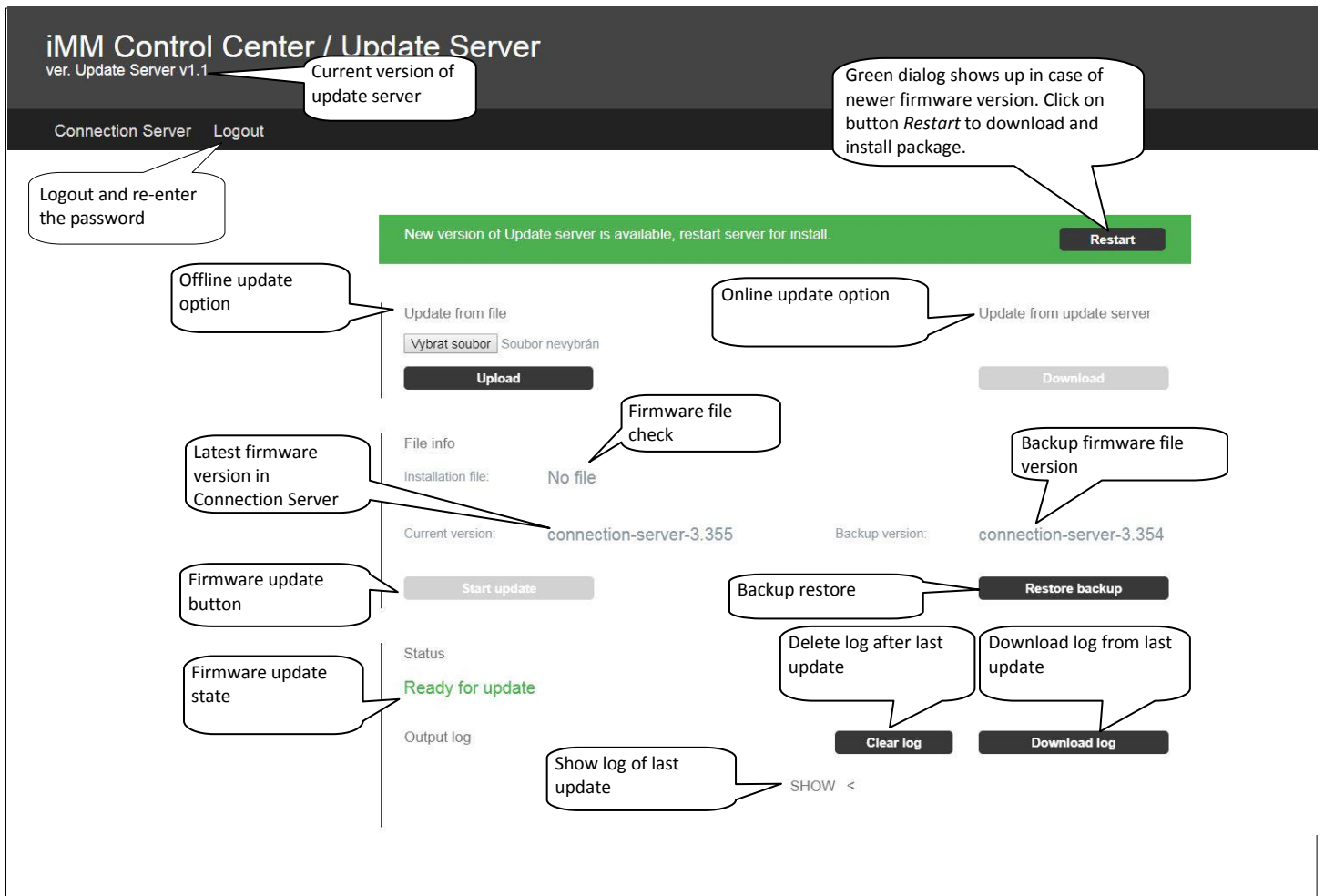
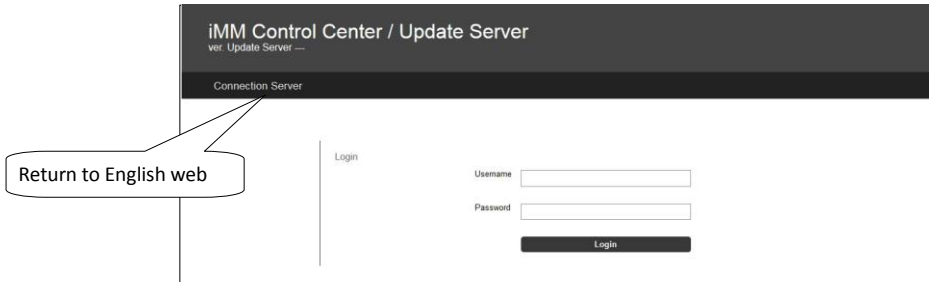



## Update form file

Update file can be downloaded from following webpage: <https://www.elkoep.com/connection-server-inels>

Choose file from local disk to be uploaded to Connection Server. Clicking on button *Upload* will transfer to Connection Server.

## Update from update server

Clicking on button *Download* will download package from public server.

## File info

Line **Installation file** will show name of uploaded package in case of successful file upload.

Clicking on button *Start update* will initiate update procedure.

Each run of update procedure will create a backup of original version to be able to revert changes in case of any unexpected error. Backup restore procedure can be initiated by clicking on button *Restore backup*.

## Status

This part shows update progress.

Clicking on button *Download log* shows update progress.

Message *Ready for update* will be shown after update procedure finishes.

## NOTE:

If update process led also to update server change, then green message with *Restart* button shows up. Click on this button in order to finish update procedure of update server.

## 4. Appendix

### Control 4

Link Control 4 with iNELS wiring using the Connection Server

Requirements for linking Control 4: iNELS3 central unit

- Controller HC-250, HC-350, HC-800, EA-3
- Composer software (2.7.2, 2.8.1, 2.8.2 and higher)
- iMM Server or Connection Server 3.219 or higher

Setting up in the licensed Composer program first step is to store iNELS drivers:

- iNELS3\_Master\_Driver.c4i - The main link driver between and Connection Server to C4
- iNELS3\_Switch.c4i - Switching units SA3
- iNELS3\_Dimmer.c4i - Dimmers DA3, DAC3
- iNELS3\_PIR.c4i - PIR sensing disturbance monitoring on IM3 input
- iNELS3\_RGB.c4i - RGB control using RFDA-73M / RGB
- iNELS3\_Therm.c4i - Temperature sensor
- iNELS3\_Thermostat.c4i - Thermostat built in iDM (heating, cooling)
- iNELS3\_Blinds.c4i - Unauthorized driver in preparation for JA3 / 20B / DC, SA3

Copy these files to C: \ Users \ user \ Documents \ Control4 \ Drivers and run Composer for.

We will connect to the IP address of the C4 (Director), and then insert it into the project

iNELS3\_Master\_Driver, to which we set the IP address of the Connection Server.

Adding the iNELS3 Driver to the project

Procedure: Switch to the System design menu and continue to the Items window where you search for "iNELS" on the Search tab and then double-click the selected driver into the project.

**! First add the iNELS3 Master Driver before inserting the other iNELS3 drivers**

Inserting an IP address into the Master Driver

Procedure: Go to the Connections menu where you select iNELS3 Master Driver and continue to the Network tab to open the iNELS 3 Master Driver and enter the IP address.

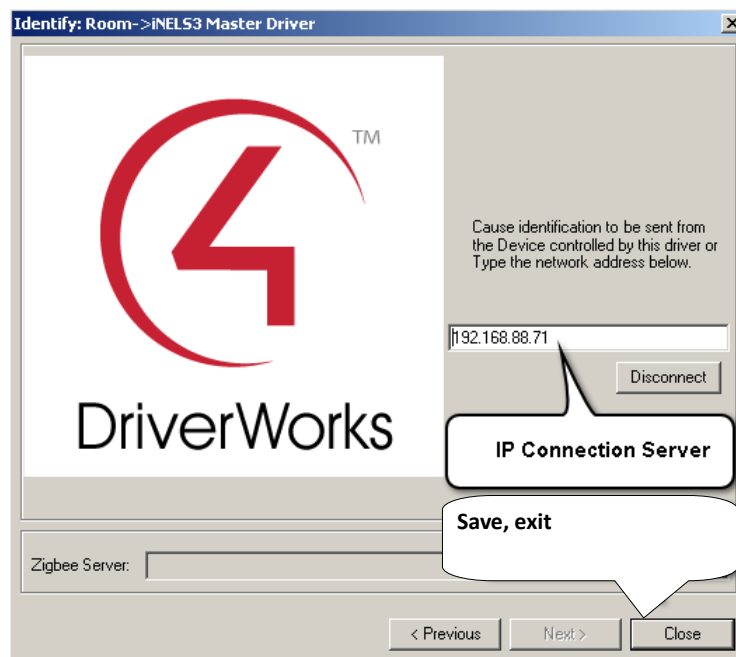

Example of inserting the dimmer into the iNELS3\_Dimmer controller

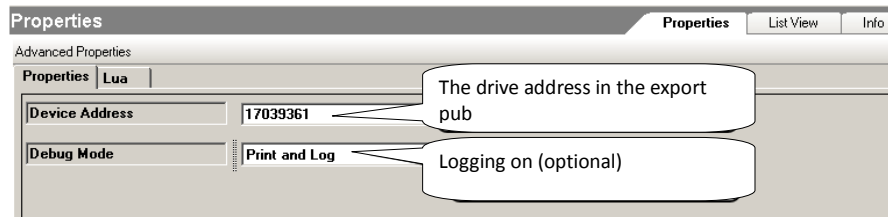

First, select the drive from the listing in iMMCC on the Configuration tab afterwards

DA3-22M\_OUT1\_000021 Y B 17039361 REAL PUB\_INOUT

We will add iNELS3\_Dimmer to the name and insert the address of the Device Address: 17039361.

Debug mode is an optional parameter, if we set Print and Log, we can validate it in the Lua Status tab.

! After completing the settings in Composer, restart the C4 directory.

- Note: The thermostat can modify the modes (attenuation, minimum, normal, comfort) based only on the next time stamp. The direct temperature setting function in the application is not yet supported.